

## IoT Pressure Sensors

# E8PC-□□0D/□□0T/□□0

### Detect Signs of Abnormalities in Cooling Water and Hydraulic Oil by Simultaneous Measurement of “Pressure + Temperature”



- Multi-sensing of “Pressure + temperature” for preventing a sudden stops or manufacturing defects.
- Various lineup of replacement adapters to enable easy replacement of your current pressure gauges and flow meters.
- Analog current output function in addition to the IO-Link communications function that can perform self-diagnosis of abnormalities in the sensor itself.

For the most recent information on models that have been certified for safety standards, refer to your OMRON website.

Refer to *Safety Precautions* on page 10.

## Ordering Information

### Sensors [Refer to *Dimensions* on page 12.]







Appearance	Applicable fluid *	Rated pressure range	Control output	Communication method	IO-Link baud rate	Model
	Liquid and gas	-0.1 to 1 MPa	PNP	IO-Link Analog	COM2 (38.4 kbps)	<b>E8PC-010D-E</b>
			NPN	Analog	---	<b>E8PC-010-E</b>
	Liquid	0 to 10 MPa	PNP	IO-Link Analog	COM2 (38.4 kbps)	<b>E8PC-100D-E</b>
			NPN	Analog	---	<b>E8PC-100-E</b>
		0 to 40 MPa	PNP	IO-Link Analog	COM2 (38.4 kbps)	<b>E8PC-400D-E</b>
			NPN	Analog	---	<b>E8PC-400-E</b>

**Note:** Please contact your OMRON sales representative regarding the IO-Link setup file (IODD file).

\* The applicable fluid is a liquid that do not erode the liquid contact part materials (such as water, glycol solution, and oil).

**Adapters** [Refer to *Dimensions on page 12.*]

It must be selected from the adapters below.



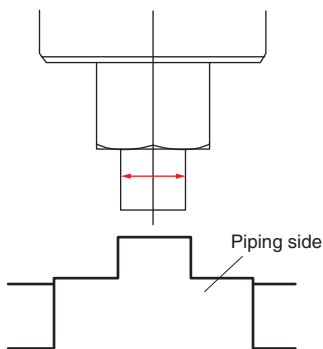

Appearance	Type	Nominal diameter of thread *		Thread type	Materials	Model
		Nominal diameter A	Nominal diameter B			
	R1/8 male	6 A	1/8"	R (taper thread)	SUS304	<b>E8PC-YA-A18</b>
	R1/4 male	8 A	1/4"	R (taper thread)	SUS304	<b>E8PC-YA-A14</b>
	R3/8 male	10 A	3/8"	R (taper thread)	SUS304	<b>E8PC-YA-A38</b>
	G1/4 female	8 A	1/4"	G (parallel thread)	SUS304	<b>E8PC-YA-B14N</b>
	NPT1/8 male	6 A	1/8"	NPT (taper thread)	SUS304	<b>E8PC-YA-C18</b>
	NPT1/2 male	8 A	1/4"	NPT (taper thread)	SUS304	<b>E8PC-YA-C14</b>

\* The nominal diameter of the thread is the size of the part shown below on the adapter.



## Cables (Sensor I/O Connectors)

A Cable is not provided with the Sensor. It must be ordered separately.



Type	Appearance	Cable	Model
Socket on one cable end	Straight 	2 m	<b>XS5F-D421-D80-F</b>
		5 m	<b>XS5F-D421-G80-F</b>
	L-shaped 	2 m	<b>XS5F-D422-D80-F</b>
		5 m	<b>XS5F-D422-G80-F</b>
Socket and plug on cable ends *	Straight/straight 	2 m	<b>XS5W-D421-D81-F</b>
		5 m	<b>XS5W-D421-G81-F</b>
	L-shaped/L-shaped 	2 m	<b>XS5W-D422-D81-F</b>
		5 m	<b>XS5W-D422-G81-F</b>

**Note:** Refer to *Sensor I/O Connector/Sensor Controller* on your OMRON website for details.

\* Straight type/L-shape type combinations are also available.

## Throttle [Refer to *Dimensions* on page 13.]



If the excessive pulsation or surge voltage is expected, use a throttle. Install it inside the adapter and use.

Appearance	Type	Material	Model
	For a male adapter	SUS304	<b>E8PC-YS</b>
	For a female adapter	SUS304	<b>E8PC-YS-N</b>

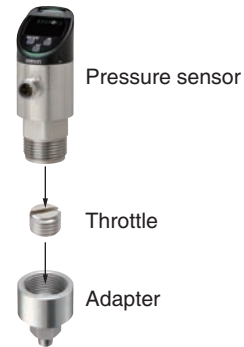
### Installation method



## O-ring (for replacement) [Refer to *Dimensions* on page 13.]

Appearance	Type	Model
	For E8PC-010□	<b>E8PC-YL-1 *</b>
	For E8PC-100□/-400□	<b>E8PC-YL-2 *</b>
	Female for adapter G1/4	<b>E8PC-YL-3</b>

\* Provided with the sensor.

# Ratings and Specifications

## Sensors

Model	PNP(COM2)	E8PC-010D-E	E8PC-100D-E	E8PC-400D-E
	PNP(COM3)	E8PC-010T-E	E8PC-100T-E	E8PC-400T-E
	NPN	E8PC-010-E	E8PC-100-E	E8PC-400-E
Pressure monitoring *1	Rated pressure range	-0.1 to 1 MPa	0 to 10 MPa	0 to 40 MPa
	Display range	-0.20 to 1.10 MPa	-0.10 to 11.00 MPa	-0.10 to 44.00 MPa
	Withstand pressure *2	4 MPa	30 MPa	50 MPa
	Burst pressure	8 MPa	60 MPa	80 MPa
	Display resolution	0.001 MPa	0.01 MPa	0.01 MPa
	Applicable fluid temperature *3	-20 to +100°C (no icing or condensation)		
	Pressure response time *4	Control output: Select 3 to 6000 ms Analog output: Set value + 2 ms (90% response)		
	Pressure monitoring precision	±1.0% of F.S. or less		
	Pressure repeatability *5	±0.3% of F.S. or less		
	Ambient temperature characteristics *6	±0.6% of F.S./10°C		
	Hysteresis	Variable		
Pressure type	Gauge pressure			
Temperature monitoring *7	Temperature monitoring rated range	-20 to 100°C		
	Temperature monitoring precision	±4°C		
	Temperature repeatability	±1°C		
Control output judgment (selectable)	Standard mode	Judge if the measured value is the threshold value or more (or less).		
	Window mode	Judge if the measured value is within the upper and lower limits.		
Compatible fluid	Gas and fluid not corroding the material of the wetted part (such as water, glycol solution, and oil)			
Display method	Numerical value indication: 4-digit 7-segment white LED with inverting function Status indicator: Normal operation (green), status indication (orange), and error (red) The content of status indication is selectable. Output indicator: OUT1 operation (orange), OUT2 operation (orange) Unit indication: E8PC-□□□□: MPa (white), E8PC-□□□□-E: MPa (white), bar (white), psi (white), °C (white) IO-Link indicator: Lighting when communications are in progress (green)			
Delay setting	1 to 9999 ms (Select a function from invalid, ON delay, OFF delay, and one-shot.)			
Connection method	M12, 4-pole connector type			
Connecting diameter	G3/4 male (Use the optional adapter to convert the diameter) Connection strength 20 N·m			
Output ch1 (selectable)	Control output	Pressure control output (N.O./N.C.) E8PC-□□□□D/T: PNP E8PC-□□□: NPN 30 VDC or less, Class 2, max. 100 mA, residual voltage 1 V or less		
Output ch2 (selectable)	Control output	Pressure control output (N.O./N.C.) / temperature control output (N.O./N.C.) E8PC-□□□□D/T: PNP E8PC-□□□: NPN 30 VDC or less, Class 2, 100 mA max., residual voltage 1 V or less		
	Analog current output *8	Pressure analog output / Temperature analog output Current output 4 to 20 mA (maximum load resistance 350Ω or less) (Display value ± 2% of F.S.)		
	External input	One-point teaching, zero point adjustment input (selectable, initial status: invalid) short-circuit current 1.5 mA or less, input time 20 ms or more		

Model	PNP(COM2)	E8PC-010D-E	E8PC-100D-E	E8PC-400D-E
	PNP(COM3)	E8PC-010T-E	E8PC-100T-E	E8PC-400T-E
	NPN	E8PC-010-E	E8PC-100-E	E8PC-400-E
IO-Link	IO-Link specification	Ver 1.1		
	Baud rate	E8PC-□□□D: COM2 (38.4kbps) E8PC-□□□T: COM3 (230.4Kbps)		
	Data length	PD Size: 6 byte OD Size: 1 byte (M-sequence type: TYPE_2_V)		
	Minimum cycle time	E8PC-□□□D (COM2): 3.2 ms E8PC-□□□T (COM3): 2.0 ms		
Power supply	Power supply voltage	10 to 30 VDC (including 10% ripple (p-p)), Class 2		
	Power consumption	1,200 mW or less (When power supply voltage is 30 V, current consumption must be 40 mA or less. When power supply voltage is 10 V, current consumption must be 120 mA or less.)		
Protection circuit		Power supply reverse connection protection, output short-circuit protection, and output reverse connection protection		
Environment resistance	Ambient temperature range	-20 to 70°C in operation and storage, respectively (no condensation)		
	Ambient humidity range	-35 to 85%RH in operation and storage, respectively (no condensation)		
	Vibration resistance (destruction)	1000 VAC, 50/60 Hz, 1 min. between current-carrying parts and case		
	Shock resistance (destruction)	10 to 2000 Hz, double amplitude 1.5 mm, 2 hours in X/Y/Z direction each		
	Impact (endurance)	500 m/s <sup>2</sup> , three times in X/Y/Z direction each		
	Protective structure	IP67		
	Pollution degree	3		
	Altitude	2,000 m or less		
Material	Installation place	Indoor		
	Wetted part	Pressure port: SUS304L, diaphragm pressure port: Al <sub>2</sub> O <sub>3</sub> (alumina), O-ring: FKM		
	Other than wetted part	Head: PPSU, display unit: PES, button: PBT, chassis: SUS304L		
Weight		Approx. 190 g		
Accessories		<ul style="list-style-type: none"> <li>• Throttle (Model E8PC-YS and E8PC-YS-N), one each</li> <li>• O-ring x 1 (Model E8PC-010: Model E8PC-YL-1, Model E8PC-100/400: Model E8PC-YL-2)</li> <li>• Ferrite core x 1 (TDK's Model ZCAT1730-0730A)</li> <li>• User's manual (Japanese, English, and Chinese), one each</li> <li>• Compliance sheet</li> <li>• Index list</li> </ul>		

\*1. The pressure precision is defined based on the values measured in the ordinary temperature environment (approx. 23°C) using water at the ordinary temperature (approx. 23°C).

\*2. Even instantaneous pressure fluctuation such as water hammer must be within the withstand pressure. If instantaneous pressure fluctuation is expected, use the throttle included in the package.

\*3. If the pipe temperature exceeds 70°C, do not contact any cables with the pipe.

\*4. The maximum actual response time has error of 1 ms when the set response time is 3 to 10 ms, 5 ms when it is 11 to 100 ms, and +5% when it is 101 ms or more.

\*5. The pressure repeatability is the error of the detection point when pressure is applied repeatedly in the ordinary temperature environment (approx. 23°C) using water at the ordinary temperature (approx. 23°C) in the rated pressure range.

\*6. The ambient temperature characteristics are prescribed based on the value measured using oil as applying a pressure value of 50% of the maximum rated pressure.

\*7. The temperature monitoring precision is prescribed based on the value measured using water.

Temperature measurements are affected by both of the temperatures, the medium and the piping.

Temperature measuring elements are installed on the back surface of the piezoelectric element (inside the product) and used to measure the temperature. It might take long for the measured value to get stable according to the heat transmission speed.

\*8. Do not connect CH 2 (pin 2) with the IO-Link master unit in analog current output mode. Otherwise, the unit might fail.

# I/O Circuit Diagrams

## PNP output

Model	Output mode	I/O Circuit Diagrams *		
		External input mode	Control output mode	Analog current output mode
E8PC-□□□D-E E8PC-□□□T-E	Standard I/O mode (SIO mode)			
	IO-Link mode			

\* Pin 2 input/output can be switched with either the operation buttons or the IO-Link communication command, "Pin 2 switching mode selection."

## NPN output

Model	Output mode	I/O Circuit Diagrams *		
		External input mode	Control output mode	Analog current output mode
E8PC-□□□-E	---			

\* Pin 2 input/output can be switched with the operation buttons.

### Connector Pin Arrangement

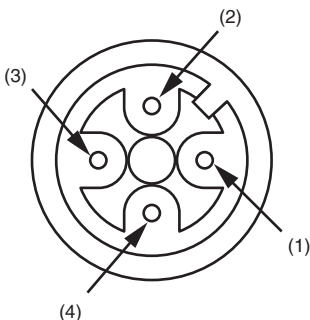

Applicable OMRON connector cables: XS5F/XS5W Series  
Applicable IO-Link master unit: NX/GX series

Pin No.	E8PC-□□□D-E E8PC-□□□T-E		E8PC-□□□-E
	Standard I/O mode	IO-Link mode	
(1)	+V	+V	+V
(2)	EXTIN/Analog/OUT2 *	Analog/OUT2 *	EXTIN/Analog/OUT2 *
(3)	0 V	0 V	0 V
(4)	C/Q	C/Q	Q

EXTIN: External input  
Q: Control output  
C: IO-Link communications

\* Pin 2 input/output can be switched with either the operation buttons or the IO-Link communication command, "Pin 2 switching mode selection."

## Timing Charts

The timing chart is described below by using the pressure control output of OUT1 as an example.  
The activity is the same even when temperature control output is set in OUT2.

### PNP output

Model	Output mode	N.O./N.C. setting *1	Timing charts *2	
			Standard mode	Window mode
E8PC-□□□D-E E8PC-□□□T-E	Standard I/O mode (SIO mode)	N.O. *3	<p>Pressure ↑ Threshold level Hysteresis Time</p> <p>OUT1 control output ON OFF OUT1 operation indicator (orange) ON OFF</p>	<p>Pressure ↑ Threshold level.H Threshold level.L Hysteresis Time</p> <p>OUT1 control output ON OFF OUT1 operation indicator (orange) ON OFF</p>
		N.C.	<p>Pressure ↑ Threshold level Hysteresis Time</p> <p>OUT1 control output ON OFF OUT1 operation indicator (orange) ON OFF</p>	<p>Pressure ↑ Threshold level.H Threshold level.L Hysteresis Time</p> <p>OUT1 control output ON OFF OUT1 operation indicator (orange) ON OFF</p>
	IO-Link mode	N.O. *3	<p>Pressure ↑ Threshold level Hysteresis Time</p> <p>Communication indicator (Green) Lighting OUT1 control output (Byte1_bit0) 1 0 OUT1 operation indicator (orange) ON OFF</p>	<p>Pressure ↑ Threshold level.H Threshold level.L Hysteresis Time</p> <p>Communication indicator (Green) Lighting OUT1 control output (Byte1_bit0) 1 0 OUT1 operation indicator (orange) ON OFF</p>
		N.C.	<p>Pressure ↑ Threshold level Hysteresis Time</p> <p>Communication indicator (Green) Lighting OUT1 control output (Byte1_bit0) 1 0 OUT1 operation indicator (orange) ON OFF</p>	<p>Pressure ↑ Threshold level.H Threshold level.L Hysteresis Time</p> <p>Communication indicator (Green) Lighting OUT1 control output (Byte1_bit0) 1 0 OUT1 operation indicator (orange) ON OFF</p>

\*1. The N.O./N.C. setting can be changed by the operation buttons or IO-Link communications.

\*2. The timer function can be set individually for OUT1 and OUT2 by the operation buttons or IO-Link communications.  
(Selection of ON delay, OFF delay, or one-shot function, and selection of a timer time from 1 to 9999 ms)  
The delay timing of each function is same as the NPN output. Refer to the next page.

\*3. Factory default

**NPN output**

Model	N.O./N.C. setting *1	Timing charts *2	
		Standard mode	Window mode
E8PC-□□□-E	N.O. *3		
	N.C.		

\*1. The N.O./N.C. setting can be changed by the operation buttons.

\*2. The timer function can be set individually for OUT1 and OUT2 by the operation buttons.

(Selection of ON delay, OFF delay, or one-shot function, and selection of a timer time from 1 to 9999 ms)

ON delay		One-shot	
OFF delay			

\*3. Factory default



## Nomenclature

[Status indicators: green/orange/red]  
Lit up according to the measured value and setting of pressure and temperature.

[Unit indicator: white]  
Displays the current unit setting.

Mode switching  
[MODE] button  
Calls a menu, selects (determine) a menu, and switches the unit.

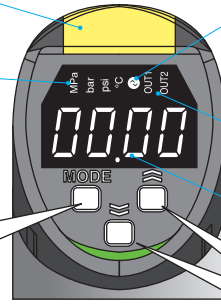

[Communication indicator: green]  
Lit up when IO-Link communications are in progress.

[Output indicator: orange]  
Lit up when output is ON.



[Measured value: white digital]  
Displays the measured value.

Switch setting  
[UP/DOWN] button  
Changes the threshold value and setting parameters.





## Safety Precautions

Be sure to read the precautions for all models in the website at: <http://www.ia.omron.com/>.

### Warning Indications

 <b>Warning</b>	Indicates a potentially hazardous situation which, if not avoided, will result in minor or moderate injury, or may result in serious injury or death. Additionally, there may be significant property damage.
 <b>Caution</b>	Indicates a potentially hazardous situation which, if not avoided, may result in minor or moderate injury or in property damage.
<b>Precautions for Safe Use</b>	Supplementary comments on what to do or avoid doing, to use the product safely.
<b>Precaution for Correct Use</b>	Supplementary comments on what to do or avoid doing, to prevent failure to operate, malfunction or undesirable effect on product performance.

### Meaning of Product Safety Symbols

	<b>General Prohibition</b> Indicates the instructions of unspecified prohibited action.
	<b>General caution</b> Indicates unspecified general alert.
	<b>Caution, explosion</b> Indicates the possibility of explosion under specific conditions.
	<b>Caution, high temperature</b> Indicates the possibility of injuries by high temperature under specific conditions.
	<b>Caution, fire</b> Indicates the possibility of fires under specific conditions.

### **WARNING**

**This product is not designed or rated for ensuring safety of persons either directly or indirectly. Do not use it for such purpose.** 

**The specification of this product is not for beverage, food, or medical chemicals. Do not use this product for the device contacting beverage, food, or medical chemicals** 

**Do not use the product with voltage in excess of the rated voltage. Excess voltage may result in malfunction or fire.** 

**This product is not assumed to be used in explosion-proof areas. Do not use the product in explosion proof areas.** 

**Never use the product with an AC power supply. Otherwise, explosion may result.** 

**The product might fail or be destroyed. Do not impress any pressure exceeding the rated value even instantaneously.** 

**The product might fail or be damaged. Do not stand on the sensor, or add excessive load.** 

**The fluid in the pipe might spout out. Tighten the prescribed O-ring to the pipe.** 

### **Caution**

**The product might fail or be damaged. Piping, wiring, maintenance, and checkup must be done by operators with expertise.** 

**The product might be damaged or fire. Do not short-circuit load.** 

**The product might be damaged or fire. Be careful with polarity of the power supply to avoid incorrect wiring.** 

**The user might get burned. The sensor surface temperature rises depending on the operating condition such as ambient temperature, power supply voltage, or fluid temperature. Be careful when operating or cleaning the product.** 

### **Precautions for Safe Use**

The following items are necessary for ensuring safety, so be sure to observe them.

- Do not use the product in the following installation areas.
  - (1) Locations subject to direct sunlight
  - (2) Locations subject to condensation due to high humidity
  - (3) Locations subject to corrosive gas
  - (4) Locations subject to vibration or mechanical shocks exceeding the rated values
  - (5) Locations subject to exposure to water, oil, chemicals
  - (6) Locations subject to stream
  - (7) Locations subjected to strong magnetic field or electric field
- Do not use in an environment exposed to an inflammable/explosive gas
- Do not use in an ambient atmosphere or environment exceeding the rating.
- Although the product is classified into IP67, do not use it in water, under the rain, or outdoor.
- Do not use the product for any inflammable, explosive, or corrosive fluids.
- Do not froze or solidify the fluid. Otherwise, the product might fail or be damaged.
- Provide a relief valve to prevent the circuit from liquid sealing.
- Make sure safety before installing/replacing the sensor, for example, stop the machine or depressurize the fluid.
- In order to ensure safety of user operations and maintenance, install the product apart from high-pressure equipment or power equipment.
- When revolving the product, support the chassis holding part with a spanner.
- Wire this product separately from high-pressure wire or power wire. If wiring together with such wire or in the same duct, this product might receive induction, which might cause malfunctioning or damages.
- Be sure to turn OFF the power before wiring.
- Do not wire with a wet hand.
- Use this product under the rated or smaller load. Otherwise, the product might be damaged or catch fire.
- Connect load correctly.

- If the load and sensor use separate power supplies, turn ON the sensor's power first.
- Process unwired terminals so that they do not contact other wire or equipment.
- Do not use the product with the main unit damaged.
- Be careful with the sharp screw parts.
- Do not pull connected cables hard.
- Do not use organic solvents such as thinner or alcohol for cleaning because they deteriorate the degree of protection and indication performance.
- Do not try to disassemble, repair, or alter the main unit.
- If disposing this product, handle it as industrial waste.
- This product is certified by the UL standard based on the assumption that Class 2 circuits are used. Operate this product using Class 2 power supply in the United States or Canada.
- Use cables of Omron model XS5F-D4 series or model XS5W-D4 series.
- The  $\text{—} \text{—} \text{—}$  mark shown on the sensor nameplate means direct current.
- Electromagnetic environment: Industrial electromagnetic environment (EN 61326-1 Table2)

**Precaution for Correct Use**

- Do not use this product as a measuring apparatus for commercial transactions.
- Do not use this product for any fluids containing impurities.
- If the fluid is non-conductive and the pipe is made of resin, ground the chassis.
- Use the product in the condition that the fluid temperature is higher than the ambient temperature. For preventing condensation, use the product as dehumidifying by air conditioning and 30 cm or more apart from cold pipes.
- Do not add excessive impart such as falling or collision.
- Do not touch the detecting unit with bare hands.
- Apply grease to the thread parts to prevent them from getting hard to remove due to seizure.
- Fasten by the prescribed torque.
- When using a cable of which diameter is different from that of the recommended cable, prepare a ferrite core suitable for the cable diameter separately.
- If using the product in IO-Link mode, keep the wiring length between the master unit and sensor 20 m or less.
- Just after the power is turned ON, it might take long for the measured value to get stable according to the operating environment.
- Do not connect CH 2 (pin 2) with the IO-Link master unit in analog current output mode. The unit might fail depending on the specification of the IO-Link master.
- Do not push the button with something sharp such as a screwdriver because doing so might damage the button.
- If using the product in an environment subject to sharp temperature variation, evaluate the product in the environment in advance.
- When implementing maintenance, use a soft brush or waste cloth so as not to damage the detecting unit or O-ring.
- When replacing the O-ring, prevent dust/dirt from being mixed into the O-ring.
- Use the product in an environment at altitudes less than 2,000 m.
- Use the product in an environment of pollution degree 3.

**Piping Method**

- Use adapters according to the connecting diameter of the pipe.
- To use the adapter, use the prescribed O-ring.
- If it is expected that the product receives excessive pulsation or surge pressure, use the throttle.
- When revolving the product, support the chassis holding part with a spanner.
- Mount the attached ferrite core at a position located within 10 mm from the edge of the cable bushing when you use this product as CE acceptable goods.

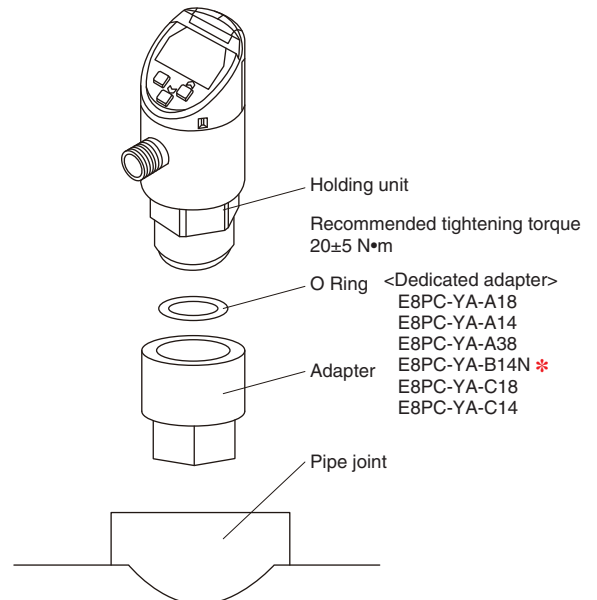
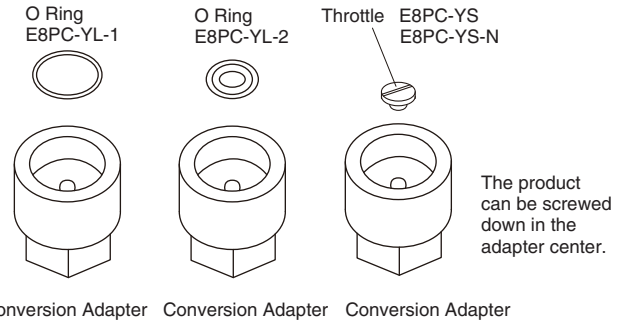

\* When using the E8PC-YA-B14N dedicated adapter, use the E8PC-YL-3 O-ring on the female side of the adapter.

# E8PC-□□0D/□□0T/□□0

## Dimensions

(Unit: mm)

### Sensors

#### IoT Pressure Sensor

E8PC-□□□-E

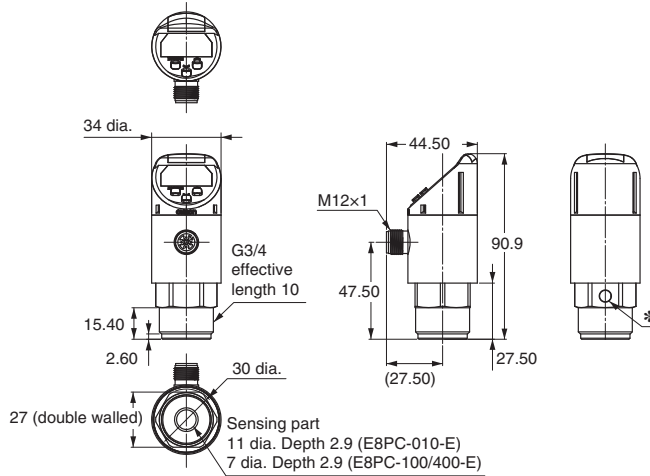

\* There is no vent in E8PC-100/400-E.

### Adapter

E8PC-YA-A□□

E8PC-YA-C□□

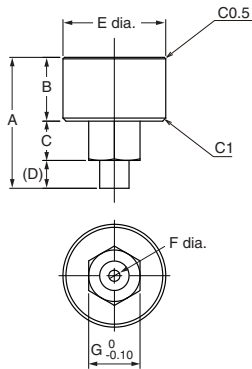

Model	E8PC-YA-A18	E8PC-YA-A14	E8PC-YA-A38	E8PC-YA-C18	E8PC-YA-C14
Thread	G3/4×R1/8	G3/4×R1/4	G3/4×R3/8	G3/4×NPT1/8	G3/4×NPT1/4
A	43.3	47.1	47.6	43.3	47.1
B	21.1				
C	13				
D	9.2	13	13.5	9.2	13
E	34				
F	3.7	4.8	5	3.7	4.8
G	17	17	19	17	17

#### E8PC-YA-B14N

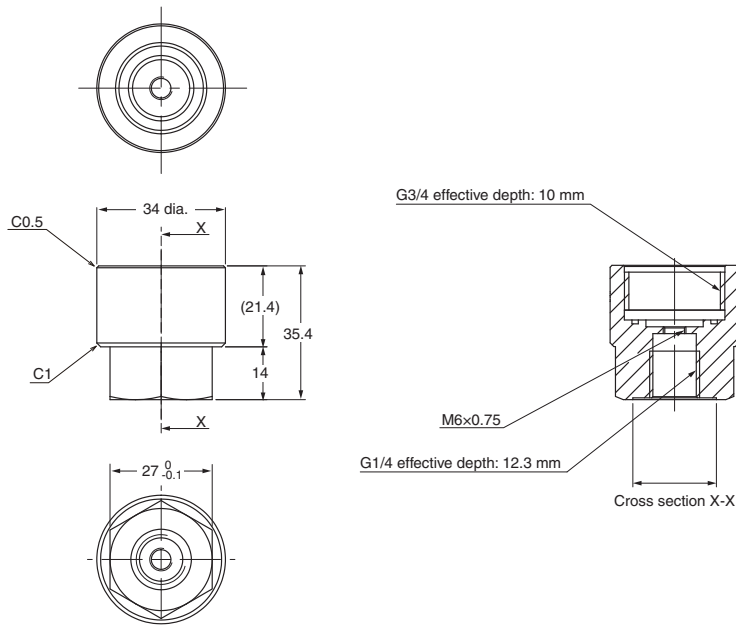

## Throttle

### E8PC-YS

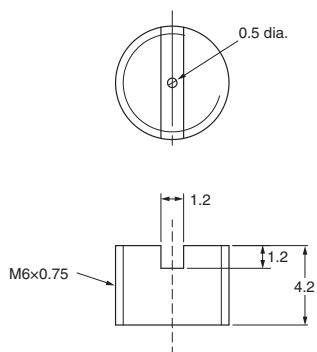

### E8PC-YS-N

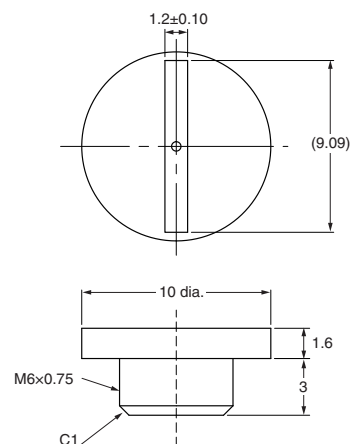

## O-ring

### E8PC-YL-1

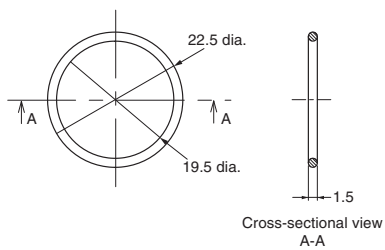

### E8PC-YL-2

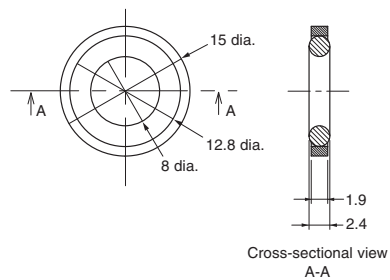

### E8PC-YL-3

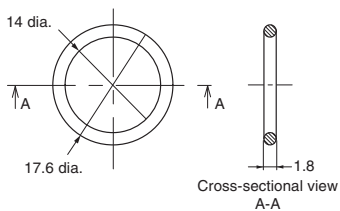

## Cable

Refer to page 28 of E8FC.



# Terms and Conditions Agreement

## **Read and understand this catalog.**

Please read and understand this catalog before purchasing the products. Please consult your OMRON representative if you have any questions or comments.

## **Warranties.**

(a) Exclusive Warranty. Omron's exclusive warranty is that the Products will be free from defects in materials and workmanship for a period of twelve months from the date of sale by Omron (or such other period expressed in writing by Omron). Omron disclaims all other warranties, express or implied.

(b) Limitations. OMRON MAKES NO WARRANTY OR REPRESENTATION, EXPRESS OR IMPLIED, ABOUT NON-INFRINGEMENT, MERCHANTABILITY OR FITNESS FOR A PARTICULAR PURPOSE OF THE PRODUCTS. BUYER ACKNOWLEDGES THAT IT ALONE HAS DETERMINED THAT THE PRODUCTS WILL SUITABLY MEET THE REQUIREMENTS OF THEIR INTENDED USE.

Omron further disclaims all warranties and responsibility of any type for claims or expenses based on infringement by the Products or otherwise of any intellectual property right. (c) Buyer Remedy. Omron's sole obligation hereunder shall be, at Omron's election, to (i) replace (in the form originally shipped with Buyer responsible for labor charges for removal or replacement thereof) the non-complying Product, (ii) repair the non-complying Product, or (iii) repay or credit Buyer an amount equal to the purchase price of the non-complying Product; provided that in no event shall Omron be responsible for warranty, repair, indemnity or any other claims or expenses regarding the Products unless Omron's analysis confirms that the Products were properly handled, stored, installed and maintained and not subject to contamination, abuse, misuse or inappropriate modification. Return of any Products by Buyer must be approved in writing by Omron before shipment. Omron Companies shall not be liable for the suitability or unsuitability or the results from the use of Products in combination with any electrical or electronic components, circuits, system assemblies or any other materials or substances or environments. Any advice, recommendations or information given orally or in writing, are not to be construed as an amendment or addition to the above warranty.

See <http://www.omron.com/global/> or contact your Omron representative for published information.

## **Limitation on Liability; Etc.**

OMRON COMPANIES SHALL NOT BE LIABLE FOR SPECIAL, INDIRECT, INCIDENTAL, OR CONSEQUENTIAL DAMAGES, LOSS OF PROFITS OR PRODUCTION OR COMMERCIAL LOSS IN ANY WAY CONNECTED WITH THE PRODUCTS, WHETHER SUCH CLAIM IS BASED IN CONTRACT, WARRANTY, NEGLIGENCE OR STRICT LIABILITY.

Further, in no event shall liability of Omron Companies exceed the individual price of the Product on which liability is asserted.

## **Suitability of Use.**

Omron Companies shall not be responsible for conformity with any standards, codes or regulations which apply to the combination of the Product in the Buyer's application or use of the Product. At Buyer's request, Omron will provide applicable third party certification documents identifying ratings and limitations of use which apply to the Product. This information by itself is not sufficient for a complete determination of the suitability of the Product in combination with the end product, machine, system, or other application or use. Buyer shall be solely responsible for determining appropriateness of the particular Product with respect to Buyer's application, product or system. Buyer shall take application responsibility in all cases.

NEVER USE THE PRODUCT FOR AN APPLICATION INVOLVING SERIOUS RISK TO LIFE OR PROPERTY OR IN LARGE QUANTITIES WITHOUT ENSURING THAT THE SYSTEM AS A WHOLE HAS BEEN DESIGNED TO ADDRESS THE RISKS, AND THAT THE OMRON PRODUCT(S) IS PROPERLY RATED AND INSTALLED FOR THE INTENDED USE WITHIN THE OVERALL EQUIPMENT OR SYSTEM.

## **Programmable Products.**

Omron Companies shall not be responsible for the user's programming of a programmable Product, or any consequence thereof.

## **Performance Data.**

Data presented in Omron Company websites, catalogs and other materials is provided as a guide for the user in determining suitability and does not constitute a warranty. It may represent the result of Omron's test conditions, and the user must correlate it to actual application requirements. Actual performance is subject to the Omron's Warranty and Limitations of Liability.

## **Change in Specifications.**

Product specifications and accessories may be changed at any time based on improvements and other reasons. It is our practice to change part numbers when published ratings or features are changed, or when significant construction changes are made. However, some specifications of the Product may be changed without any notice. When in doubt, special part numbers may be assigned to fix or establish key specifications for your application. Please consult with your Omron's representative at any time to confirm actual specifications of purchased Product.

## **Errors and Omissions.**

Information presented by Omron Companies has been checked and is believed to be accurate; however, no responsibility is assumed for clerical, typographical or proofreading errors or omissions.

· Other company names and product names in this document are the trademarks or registered trademarks of their respective companies.

**OMRON Corporation Industrial Automation Company**

Kyoto, JAPAN

Contact: [www.ia.omron.com](http://www.ia.omron.com)

**Regional Headquarters**

**OMRON EUROPE B.V.**

Wegalaan 67-69, 2132 JD Hoofddorp  
The Netherlands  
Tel: (31)2356-81-300/Fax: (31)2356-81-388

**OMRON ASIA PACIFIC PTE. LTD.**

438B Alexandra Road, #08-01/02 Alexandra  
Technopark, Singapore 119968  
Tel: (65) 6835-3011/Fax: (65) 6835-2711

**OMRON ELECTRONICS LLC**

2895 Greenspoint Parkway, Suite 200  
Hoffman Estates, IL 60169 U.S.A.  
Tel: (1) 847-843-7900/Fax: (1) 847-843-7787

**OMRON (CHINA) CO., LTD.**

Room 2211, Bank of China Tower,  
200 Yin Cheng Zhong Road,  
PuDong New Area, Shanghai, 200120, China  
Tel: (86) 21-5037-2222/Fax: (86) 21-5037-2200

**Authorized Distributor:**

© OMRON Corporation 2022 All Rights Reserved.  
In the interest of product improvement,  
specifications are subject to change without notice.

**Cat. No. E609-E1-01**

0622 (0622)