

WORKSHOP SPECIFICATIONS

XL³ 400 et XL³ 800

CABINETS AND ENCLOSURES



With its extensive ranges, the Legrand offer meets your quality standards and provides real freedom and simplicity of installation together with acknowledged reliability.

XL³ 400 and XL³ 800 cabinets and enclosures enable you to make optimum use of Legrand's concept of product integration. Whichever enclosure you choose, and whatever your preferred way of working and the technical requirements of your installations, you will find what you need in the XL³ range.

XL³ 400 and XL³ 800 cabinets and enclosures offer a wide range of solutions and innovations for quick, safe assembly:

- Metal or insulated enclosures (IP 30-40-43 and IP 55)
- Products delivered dismantled (except for IP 55), providing total accessibility for wiring
- Optimised equipment for easy installation
- Sealable faceplates with metal 1/4 turn fastening and handles
- Screw-mounting faceplates that can be fitted with hinges
- Fast vertical or horizontal joining using 4 screws/nuts

LEGAL INFORMATION

Presentation pictures do not always include Personal Protective Equipment (PPE), but this is a legal and regulatory obligation that must be scrupulously respected.

In accordance with its continuous improvement policy, Legrand reserves the right to change the specifications and illustrations without notice. All illustrations, descriptions and technical information included in this document are provided as indications and cannot be held against Legrand.

CONTENTS

Safety instructions.....	2
The XL ³ 400 et XL ³ 800 ranges.....	4
Assembling the enclosures.....	10
XL ³ 400/800 IP 30-40-43 cabinets and enclosures.....	10
XL ³ 400 insulated cabinets.....	18
XL ³ 800 IP 55 cabinets and enclosures.....	20
Mounting the distribution systems.....	24
Optimised distribution	
VX ³ busbars.....	24
HX ³ row distribution blocks.....	27
HX ³ and VX ³ distribution blocks with automatic terminals	
Mounting VX ³ busbars at the back of the enclosure.....	28
Mounting VX ³ busbars in cable sleeves.....	31
Equipping HX ³ 250 and 400 A row distribution blocks.....	34
Mounting HX ³ plug-in distribution blocks.....	38
Mounting HX ³ and VX ³ distribution blocks with automatic terminals.....	40
Standard distribution	
Standard distribution at the back of the enclosure.....	42
Standard distribution in cable sleeves.....	45
Other distribution devices.....	47
Mounting the devices.....	48
Principle for defining the required space.....	48
French tariff connection plate.....	54
Wiring the panels.....	56
Cable entry.....	56
Wiring.....	57
Protective conductors.....	59
Output terminal blocks.....	61
Installing the enclosures.....	62
Transport and handling.....	62
Fixing the enclosures.....	63
Dimensions.....	65
Accessories.....	67

SAFETY

INSTRUCTIONS

General information

- Use only the products and accessories recommended by the Legrand Group in the catalogue, instructions, technical data sheets and all other documents provided by Legrand (hereinafter referred to as «the Documentation») in compliance with the installation rules.
- Improper installation and/or use may result in the risk of arcing in the enclosure, overheating or fire. The enclosures must be used under normal conditions, they must not be subjected to Voltage / Current / Temperature values other than those specified in the Documentation.
- Legrand declines all responsibility for any modification or repair of the equipment making up the enclosure that is not authorized by the Legrand Group, as well as any failure to comply with the rules and recommendations specified by Legrand in the Documentation. In addition, in the cases mentioned above, the warranty granted by Legrand will not be applicable.
- It is necessary to check that the characteristics of the products are appropriate for their environment and use during maintenance operations, and to refer to the Documentation. If you have any questions or require clarification, please contact Legrand Group.
- The installation, use and maintenance of the enclosures and their components must be carried out by qualified, trained and authorized personnel, in accordance with the regulations in force in each country.



RISK OF ELECTRIC SHOCK, BURNS AND EXPLOSION.

- People working on the installation must have the appropriate electrical authorizations for the work to be carried out.
- Wear the PPE (Personal Protective Equipment) necessary to work on live products.
- Respect the safety rules related to electrical work.
- Improper electrical and mechanical use of equipment can be dangerous and may result in personal injury or damage to property.
- Depending on the maintenance operations to be carried out, partial or total power cuts of the enclosure concerned should be planned before any work.
- When performing operations that involve access to the inside of the enclosure, be aware of the risk of burns before touching any products or metal parts.
- Before turning the power back on, make sure that there are no foreign bodies and that all physical protections have been put back in place (e.g.: screens, covers, shields).

Any failure to strictly apply the procedures and to respect these recommendations, could lead to serious risk of accident, endangering people and property (in particular, without limitation, risk of burns, electric shocks, etc.).



 The rules and recommendations in this document are based on our knowledge of the typical conditions of use of our products in the fields of application usually encountered. However, it is always the customer's responsibility to verify and validate that Legrand products are suitable for its installation and use.

The customer must ensure proper installation, maintenance and operation of the equipment to avoid any risk of injury to personnel or damage to property in the event of product failure, especially for applications that require a very high level of safety (e.g., those in which the failure of a component may endanger human life or health).

The rules for storage, handling, installation and maintenance and the appropriate precautions and warnings must be strictly observed and applied.

THE XL³ 400 AND XL³ 800 RANGES

XL³ 400 and XL³ 800 can be used to create enclosures suitable for all your environments.

GENERAL CHARACTERISTICS

- IP 30 to IP 55
- IK 04 to IK 08
- Class I and class II
- Fire resistance: 750°/5 s (IEC 60695-2) for installation in public buildings
- Rated short-time withstand current I_{cw}: 25 kA - 1 s
- Max. short-circuit current I_{pk}: 50 kA
- 24 or 36 modules per row
- Take devices up to 400 A for XL³ 400 (250 A for IP 55) and up to 800 A for XL³ 800 (630 A for IP 55)
- Choice of distribution: standard or optimised
- Internal or external cable sleeves (can be joined on the left or the right)
- Colour: RAL 7035
- Conform to standard IEC 61439-1

i Possibility to choose a special colour from a panel of 197 shades: RAL only possible on metal parts.

For any request about technical possibilities and extra costs, please contact the technical support:
support-technique-edia.fr-lgs@legrand.fr



36-module XL³ 800 metal enclosure with internal cable sleeve height 1950 mm

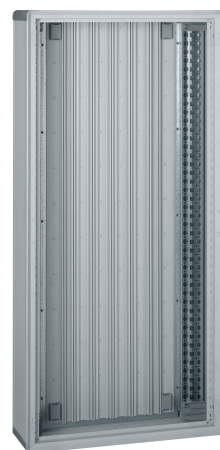

XL³ 400 insulated cabinet height 1200 mm





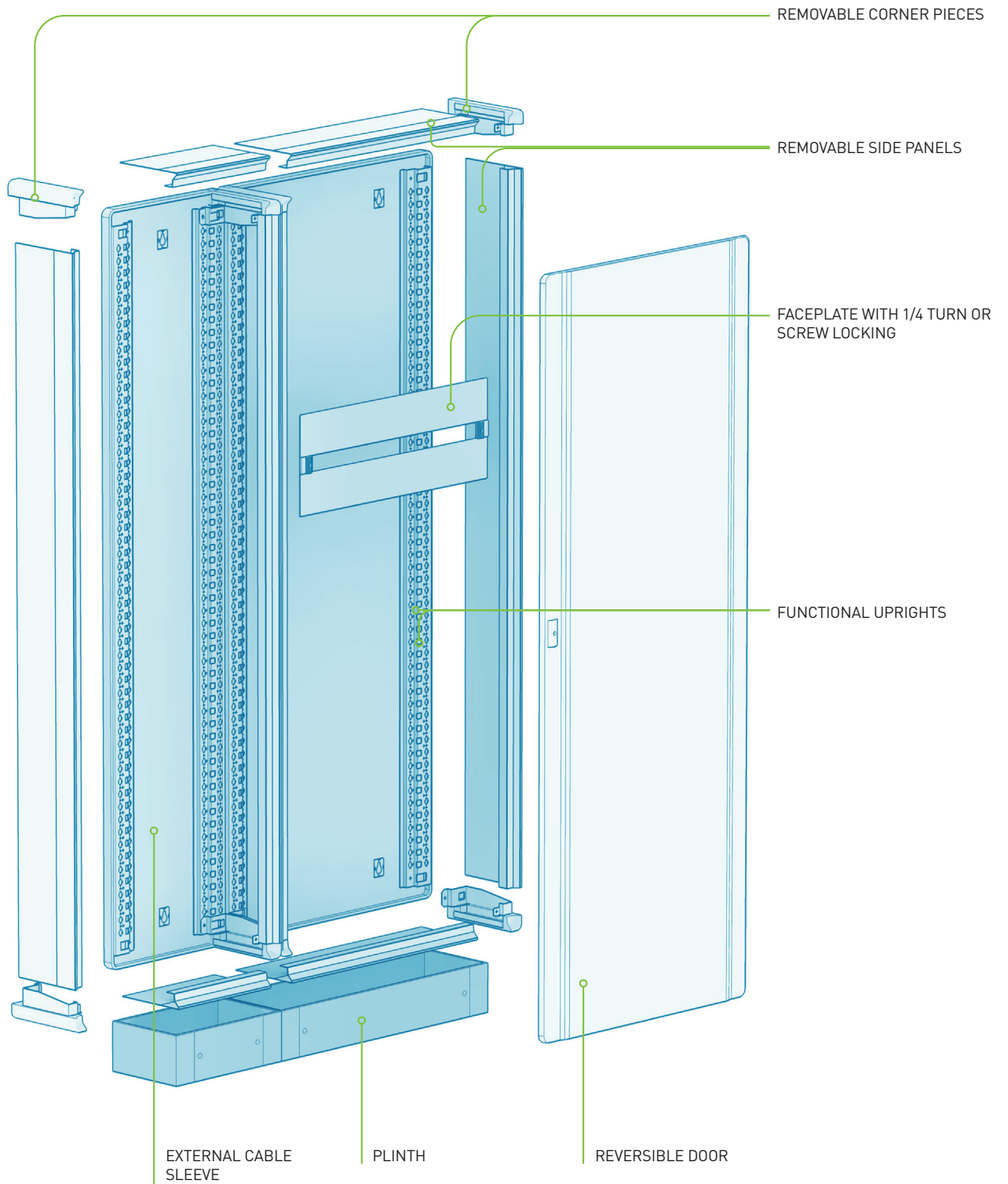

XL³ 400 one-piece IP 55 cabinet height 1115 mm



THE XL³ 400 AND XL³ 800 RANGES

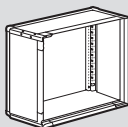
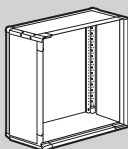
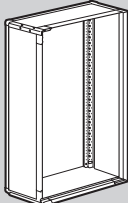
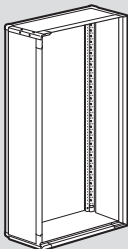
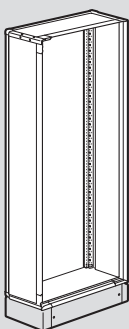
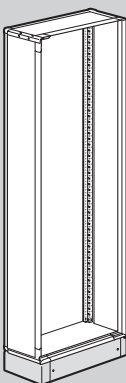
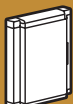

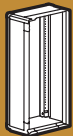



XL³ 400 IP 30-40-43 METAL CABINETS AND ENCLOSURES

- Depth: 175 mm
 - External width: 575 mm
- (see dimensions on page 65)

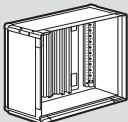
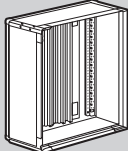
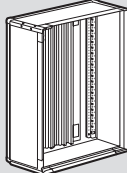
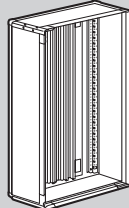
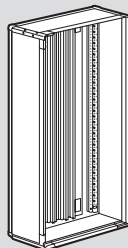
XL ³ 400 METAL		CABINETS						ENCLOSURES	
External height (mm)		600	750	900	1050	1200	1500	1600	1900
Height for faceplates (mm)		550	700	850	1000	1150	1450	1450	1750
Cat.No		 0 201 03	 0 201 04	 0 201 05	 0 201 06	 0 201 07	 0 201 08	 0 201 18	 0 201 19
Curved door		0 202 53	0 202 54	0 202 55	0 202 56	0 202 57	0 202 58	0 202 58	0 202 59
Flat door	solid 	0 202 73	0 202 74	0 202 75	0 202 76	0 202 77	0 202 78	0 202 78	0 202 79
	glass 	0 202 83	0 202 84	0 202 85	0 202 86	0 202 87	0 202 88	0 202 88	0 202 89
Cable sleeve		0 201 23	0 201 24	0 201 25	0 201 26	0 201 27	0 201 28	0 201 38	0 201 39
Solid door for cable sleeve		0 201 63	0 201 64	0 201 65	0 201 66	0 201 67	0 201 68	0 201 68	0 201 69

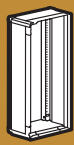

XL³ 400 IP 30-40-43 INSULATED CABINETS

- Total depth: 175 mm (without door)
 - Total width: 575 mm
- (see dimensions on page 65)

XL ³ 400 INSULATED		CABINETS				
Total height (mm)		600	750	900	1050	1200
Height for faceplates (mm)		550	700	850	1000	1150
Cat.No		 0 201 53	 0 201 54	 0 201 55	 0 201 56	 0 201 57
Curved door		0 202 53	0 202 54	0 202 55	0 202 56	0 202 57
Flat door	solid 	0 202 73	0 202 74	0 202 75	0 202 76	0 202 77
	glass 	0 202 83	0 202 84	0 202 85	0 202 86	0 202 87
Cable sleeve		0 201 73	0 201 74	0 201 75	0 201 76	0 201 77
Solid door for cable sleeve		0 201 63	0 201 64	0 201 65	0 201 66	0 201 67

XL³ 400 ONE-PIECE IP 55 CABINETS

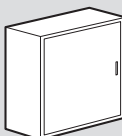
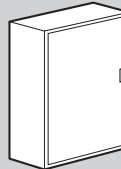
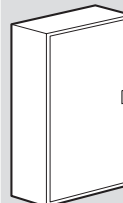

- Total depth: 215 mm (with door)
 - Total width: 650 mm
- (see dimensions on page 65)

XL ³ 400 IP 55	CABINETS			
External height (mm)	515	715	915	1115
Height for faceplates (mm)	400	600	800	1000
Cat.No	 0 201 82	 0 201 83	 0 201 84	 0 201 85

THE XL³ 400 AND XL³ 800 RANGES

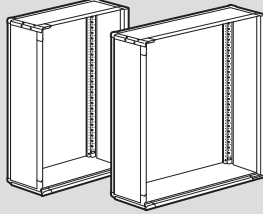
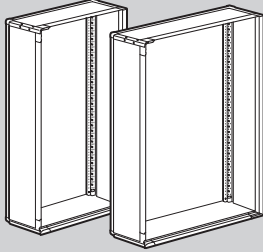
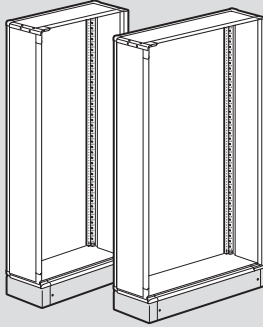
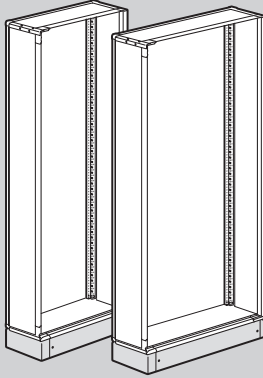

XL³ 800 METAL CABINETS AND ENCLOSURES

- IP 43 - IK 08 with kit and door
 - IP 40 - IK 08 with door
 - IP 30 - IK 07 without door
 - Total depth: 230 mm (without door)
- (see dimensions on page 66)

XL ³ 800 METAL			CABINETS				ENCLOSURES			
External height (mm)			1050		1250		1550		1950	
Height for faceplates (mm)			1000		1200		1400		1800	
External width			660	910	660	910	660	910	660	910
Number of modules / row			24	36	24	36	24	36	24	36
Cat.No										
Cat.No			0 204 01	0 204 06	0 204 02	0 204 07	0 204 03	0 204 08	0 204 04	0 204 09
Curved door	solid		0 212 51	0 212 56	0 212 52	0 212 57	0 212 53	0 212 58	0 212 54	0 212 59
	glass		0 212 61	0 212 66	0 212 62	0 212 67	0 212 63	0 212 68	0 212 64	0 212 69
Internal cable sleeve kit				0 204 26		0 204 27		0 204 28		0 204 29
Faceplate for internal cable sleeve				0 204 46		0 204 47		0 204 48		0 204 49
External cable sleeve							0 204 23		0 204 24	
Door for external cable sleeve							0 204 33		0 204 34	
Faceplate with cut-outs for external cable sleeve	DPX 250/630						0 204 43		0 204 44	
	DPX-IS 630						0 204 41		0 204 42	

XL³ 800 IP 55 CABINETS AND ENCLOSURES

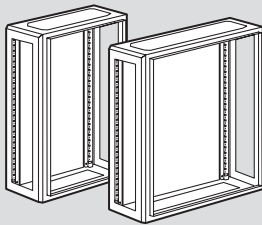
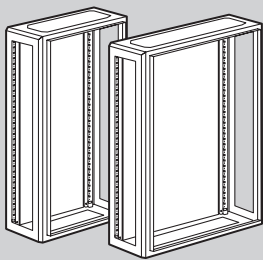
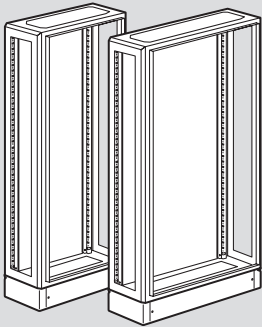
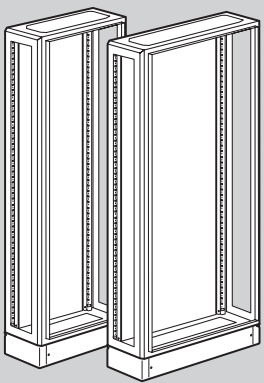
- IP 55 - IK 08 with door
 - Total depth: 250 mm (with door)
- (see dimensions on page 66)

XL ³ 800 IP 55		CABINETS				ENCLOSURES				
External height (mm)		1095		1295		1595		1995		
Height for faceplates (mm)		1000		1200		1400		1800		
External width		700	950	700	950	700	950	700	950	
Number of modules / row		24	36	24	36	24	36	24	36	
Cat.No										
Cat.No		0 204 51	0 204 56	0 204 52	0 204 57	0 204 53	0 204 58	0 204 54	0 204 59	
Flat door	solid		0 212 71	0 212 76	0 212 72	0 212 77	0 212 73	0 212 78	0 212 74	0 212 79
	glass		0 212 81	0 212 86	0 212 82	0 212 87	0 212 83	0 212 88	0 212 84	0 212 89
Internal cable sleeve kit			0 204 26		0 204 27		0 204 28		0 204 29	
Faceplate for internal cable sleeve			0 204 46		0 204 47		0 204 48		0 204 49	
External cable sleeve						0 204 73		0 204 74		
Door for external cable sleeve						0 204 83		0 204 84		
Faceplate with cut-outs for external cable sleeve	DPX 250/630					0 204 43		0 204 44		
	DPX-IS 630					0 204 41		0 204 42		
Side panels		0 204 66		0 204 67		0 204 68		0 204 69		

ASSEMBLING THE ENCLOSURES

XL³ 400/800 IP 30-40-43 METAL CABINETS AND ENCLOSURES

Metal cabinets, enclosures and cable sleeves are supplied dismantled. Each enclosure consists of a back, two functional uprights joined to the back, four corner pieces, four side panels and a cable entry plate. Enclosures more than 1550 mm high are supplied with a 100 mm plinth.



The assembly is supplied dismantled, for minimum dimensions

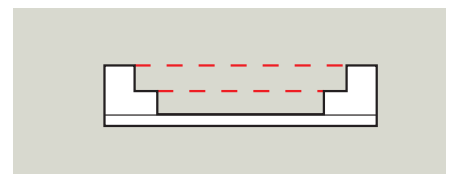

All the enclosures are supplied with an adjustable insulated cable entry plate.



The functional uprights integrated at the back of XL³ 400 and XL³ 800 enclosures have two fixing heights, for quick, reliable fixing of all equipment.

1 ASSEMBLING THE BACK AND THE CORNER PIECES

XL³ 400/800



Insert the corner pieces in the functional uprights...

2 FITTING THE SIDE PANELS



Insert the side panels in the top of the corner runners.

XL³ 400/800

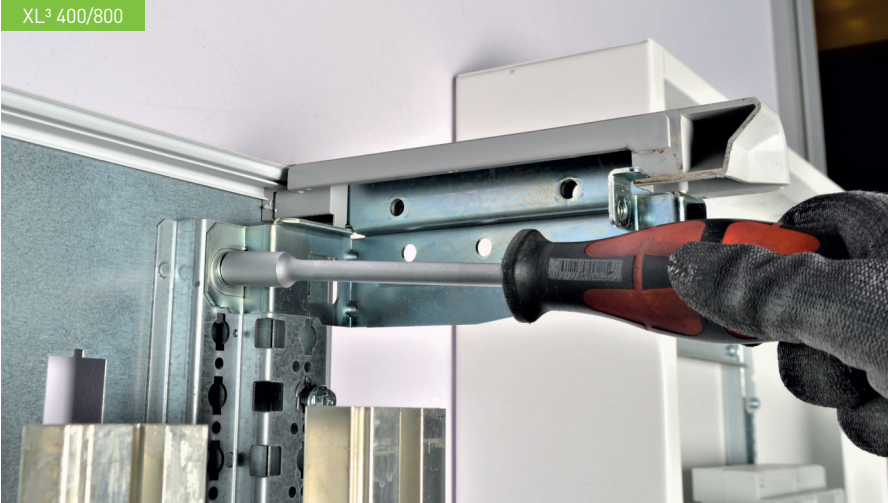

...then attach them with a single M6 x 10 screw

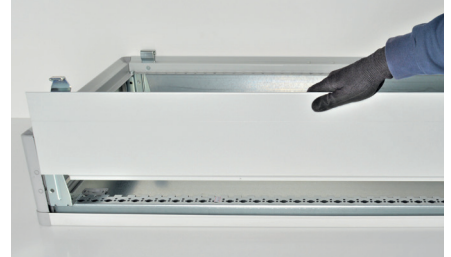

Slide the side panels in steadily until they are inserted in the back.



The side panels have a cut-out for fitting cable entry plates and for feeding the wiring through when joining enclosures.

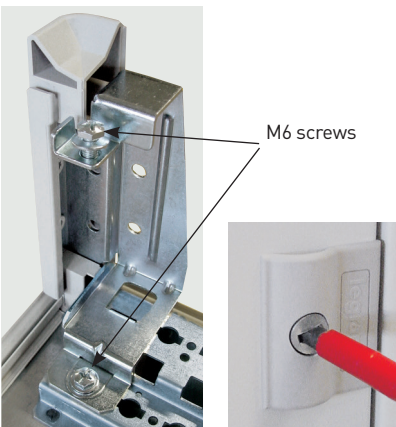

M6 screws

Standardised screws: a screwdriver and a 10 mm spanner are all that is required for complete assembly of the enclosures.

ASSEMBLING THE ENCLOSURES

3 MOUNTING AN INTERNAL CABLE SLEEVE (XL³ 800 ONLY)

36-module wide XL³ 800 cabinets and enclosures can be fitted with an internal cable sleeve using kits Cat.No 0 204 26/27/28/29. These kits consist of an intermediate functional upright, two spacers and a faceplate support upright. The cable sleeve can be installed on the right or the left.



To fix the functional upright on the cross-pieces at the back of the enclosure, insert 4 clip-nuts in the marked holes.

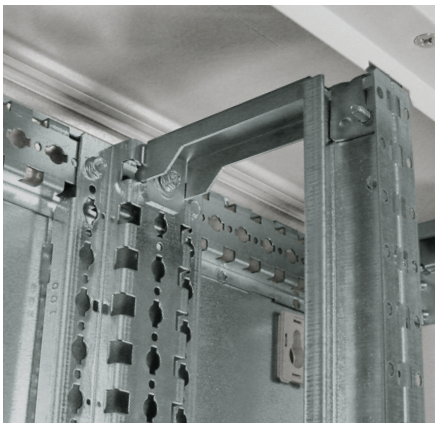

Fix the spacers at the ends of the functional upright, then fix the faceplate support on the spacers.

4 JOINING ENCLOSURES

No accessories are needed for joining cabinets and enclosures.

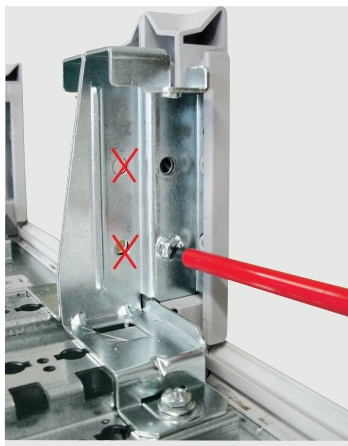

Remove the seals from the corner pieces and join the enclosures using the four M6 screws and four nuts provided.

! Care must be taken to use the correct holes

i Horizontal and vertical joinings can be used together

In the case of cable passage between joined enclosures, it is necessary to break the 2 juxtaposed uprights.



Then fix the 2 parts to the enclosures with the screws provided.

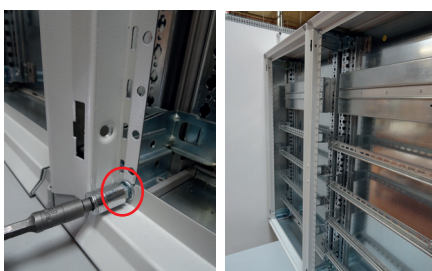

5 ASSEMBLING THE PLINTHS

As when joining enclosures, the corner piece seals must be removed before assembling the plinths.



Fix the two sides of the plinth using the four M6 screws and four nuts provided.

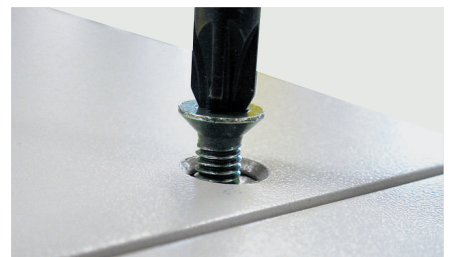

The front and rear covers of the plinth are attached using four self-tapping screws.

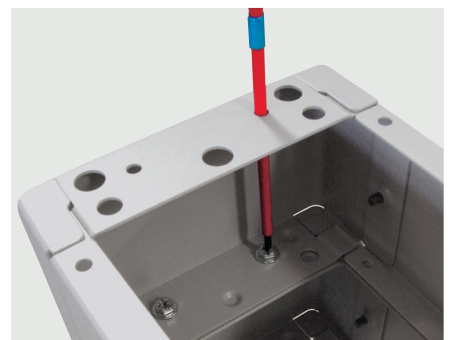

+ The plinths can be placed on top of one another for easier cable spreading.

6 MOUNTING THE DOORS

The direction in which the door opens determines the side on which the hinges and latches are fitted.

- Maximum door opening:**
- 125° (XL³ 400/800)
 - 130° (XL³ 800 with another enclosure on the hinge side)
 - 140° (XL³ 400 IP55/800 IP55 for a single enclosure)

■ Enclosures ≥ 1550 mm high

To mount the doors, the enclosures must be fitted with 3 hinges on one side and 2 latches on the other.

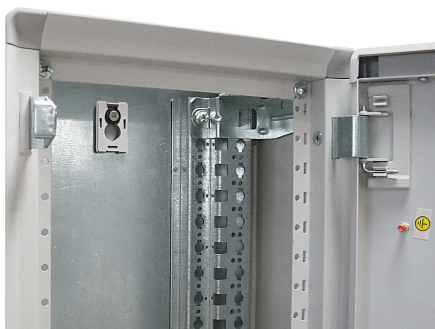

Enclosure equipped for opening to the right. To reverse the way the door opens, fit the hinges on the left and the latches on the right. The door itself will be turned round 180 degrees. The mechanism which operates the connecting rods must also be dismantled and turned round 180 degrees.

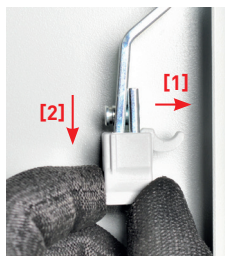

Release the two linking rings from the connecting rods and the mechanism.



Unscrew the two screws fixing the handle and the mechanism.

Reverse the connecting rods, then reassemble the mechanism in the same way.



For an optimum finish, insert the dummy strips in the hinge opening.



The door is opened in 2 steps:
1 - Disengage
2 - Rotate

■ Enclosures 900 to 1200 mm high

The doors are fitted with a central handle with 2-point lock.



The door can open to the right or the left, depending on which side the hinges and latches have been fitted.

■ Enclosures < 900 mm high (XL³ 400 only)



To mount the doors, fit the enclosures with two hinges on one side and a door release on the other.

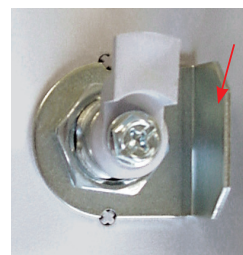

It is essential to fit the metal bracket so that the handle locks correctly.

ASSEMBLING THE ENCLOSURES

7 FITTING THE KEY BARRELS

The method differs according to the type of handle used.

■ Large handles (enclosures \geq 1550 mm high)

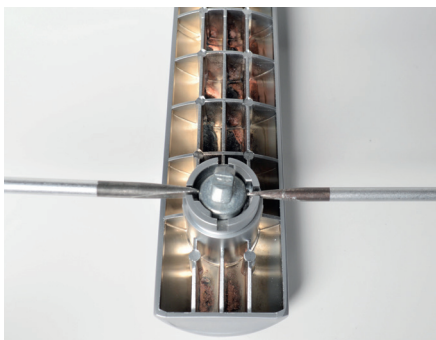

Push in the two black clips to remove the blanking plate

■ Small handles (enclosures $<$ 1550 mm high)

Once the handle has been dismantled (M6 screw) the blanking plate is automatically released.



Combine the adaptor casing and barrel assembly with the black adaptor.



Refit the handle on its support.



Combine the adaptor casing and barrel assembly with the aluminium adaptor.



Insert the pin in the notch towards the front.



The self-adhesive document holder Cat.No 0 365 82 is attached on the inside of the door.



Insert the assembled barrel in the body of the handle.



Insert the assembled barrel in the body of the handle.



8 FACEPLATES

■ Faceplates for cabinets and enclosures

There are two versions of metal faceplate:
 - ¼ turn locking, for 24-module XL³ 400 and XL³ 800
 - Screw locking, for 24 and 36-module XL³ 800

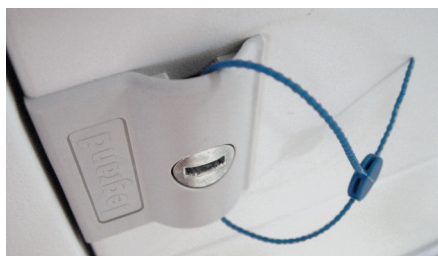

The ¼ turn faceplates are sealable.

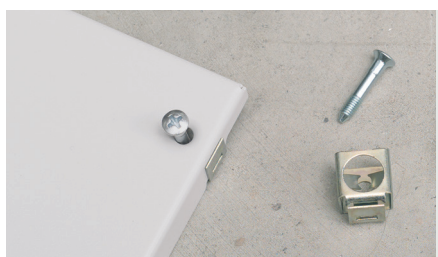

The screw-mounting faceplates are supplied with captive screws and clip-nuts which must be fitted on the faceplate support uprights.

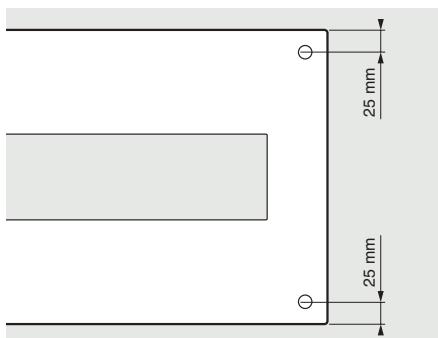

The screws are always positioned 25 mm from the top and bottom of the faceplate.

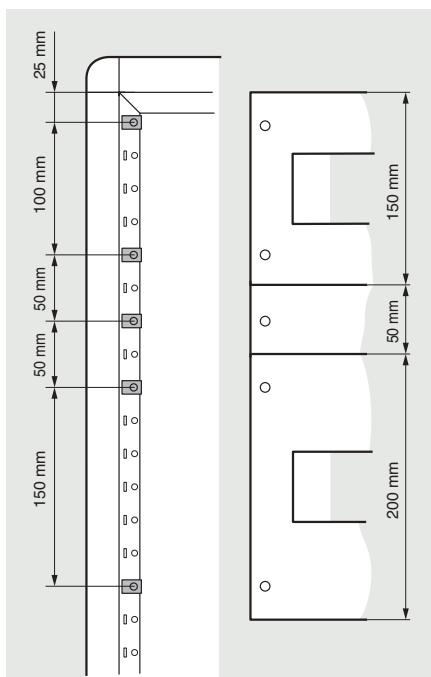

Example of the installation of the clip-nuts for three faceplates, heights: 150, 50 and 200 mm. The 1st clip-nut is always positioned in the 1st hole.



The screw-mounting faceplates can be fitted with hinges Cat.No 0 209 59 on the right or the left.



Installing ventilating faceplates Cat.No 0 209 49 and 0 209 99 (24 and 36 modules), height 200 mm, at the top and/or bottom of the XL³ 800 enclosure provides natural ventilation for heat dissipation.



ASSEMBLING THE ENCLOSURES

■ Cable sleeve faceplates

The cable sleeves take solid metal faceplates. They are supplied with hinges and locks which can be fitted on the left or the right. The fixing positions for the clip-nuts on the faceplate support upright are given below.



Faceplates ≥ 1400 mm high have cut-outs for DPX 250, 630 with or without e.l.c.b. underneath or DPX-IS 630.



The faceplate hinges can be fitted on the right or the left

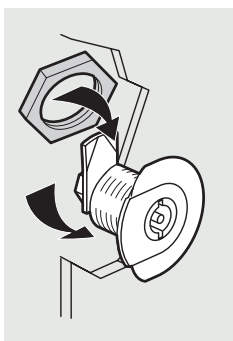

Insert the two locks in the cut-outs on the front cover on the side opposite the hinges and fix them using the nuts provided.

9 EQUIPOTENTIAL LINK FOR THE DOOR AND FACEPLATES

If control and signalling units with voltage $U > 50$ V are fitted, the doors are equipped with studs for connecting the equipotential link conductor Cat.No 0 373 85.



Conductor Cat.No 0 373 85 has an "eye-let terminal" at each end. Feed the conductor behind the hinge to avoid getting in the way of the faceplate.



 The equipotential link for 1/4 turn faceplates is provided by the latch bolt.

The earth terminal is only provided when devices are mounted on the faceplate.

Fixing positions for hinges and clip-nuts (in mm)

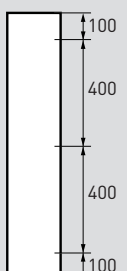
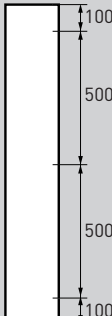
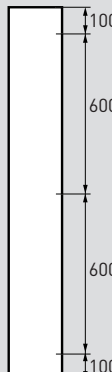
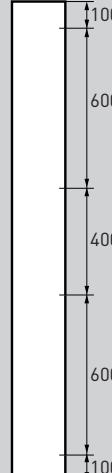
				
Height (mm)	1000	1200	1400	1800
Cat.No	0 204 46	0 204 47	0 204 48	0 204 49

10 OBTAINING IP 43 PROTECTION

IP 43 is obtained by installing a door fitted with seal Cat.No 0 201 30 and the insulated cable entry plate supplied with the enclosure.



The plate is fitted after the upper side panel has been cut.



The seal must be fitted in the bottom of the door.

ASSEMBLING THE ENCLOSURES

XL³ 400 INSULATED CABINETS

Like the metal cabinets, XL³ 400 insulated cabinets and cable sleeves are supplied dismantled in reusable packaging. Each enclosure consists of a back, four corner pieces, four side panels and a faceplate frame in four separate parts. The metal back, joined to the functional uprights, provides optimum rigidity. Inside it is fitted with an insulated backplate which can take C-section busbars Cat.No 4 044 30/31 and supports Cat.No 4 044 37/38 to create VX³ optimised busbars. It is insulated at the back to ensure it is class II. All the other parts of the enclosure are made of insulated plastic.



1 ASSEMBLING THE CABINETS AND CABLE SLEEVES

As with metal enclosures, each corner piece is inserted in the functional uprights and attached using an M6 screw (see page 11).

The side panels are fitted by sliding them in the corner runners. They are held in place by the faceplate frame.

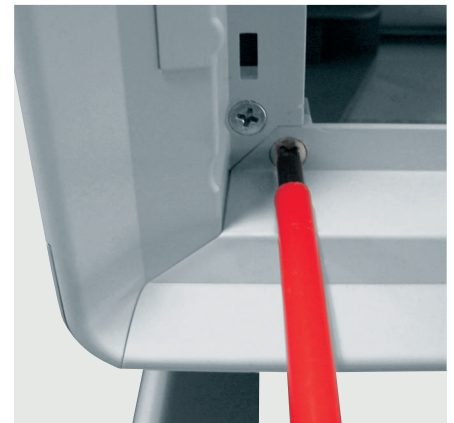

Each side of the frame is attached separately to the corner pieces by 2 Phillips screws



The backs of the insulated cabinets are ready to take C-section busbars to create an active backplate.

2 JOINING THE ENCLOSURES

Cabinets and cable sleeves are joined horizontally or vertically in the same way as for metal enclosures (see page 12). For the cable feedthroughs, simply do not mount the side panels.

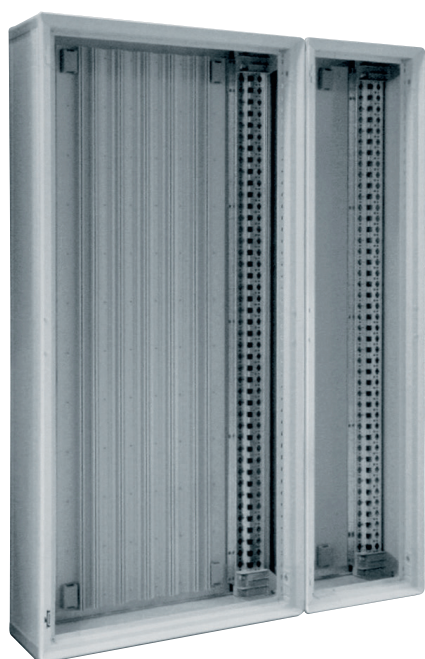

Joining a cabinet and a cable sleeve

3 MOUNTING THE DOORS

The methods for mounting and reversing the doors are exactly the same as those for metal enclosures (see page 13). Fitting the seal Cat.No 201 30/32 on the door provides IP 43 protection (see page 17).



The blanking plates for the unused hinge positions are held in place by a screw, which can be inserted without any tool.

4 FACEPLATES

Insulated faceplates, like metal faceplates, have a sealable ¼ turn lock.



The shape of the faceplates is specially designed for ease of handling.

5 COMPLIANCE WITH CLASS II

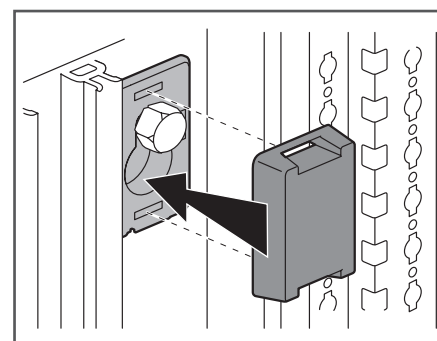

To comply with class II, replace the plastic covers that are supplied to insulate the fixing screws.

ASSEMBLING THE ENCLOSURES

XL³ 800 IP 55 CABINETS AND ENCLOSURES

XL³ 800 IP 55 cabinets, enclosures and cable sleeves are one-piece metal enclosures. They have cable gland plates at the top and bottom, and side openings for creating assemblies by horizontal joining. They are supplied without side panels. They take solid rounded metal or glass doors (to be ordered separately). The enclosures ($H \geq 1595$ mm) are supplied with a 100 mm plinth. The cabinets and enclosures are available in two widths: 24 and 36 modules. The 36-module enclosures can take an internal cable sleeve.



The ease of joining XL³ 800 enclosures together provides a great deal of freedom for creating IP 55 distribution assemblies.

1 FITTING THE SIDE PANELS

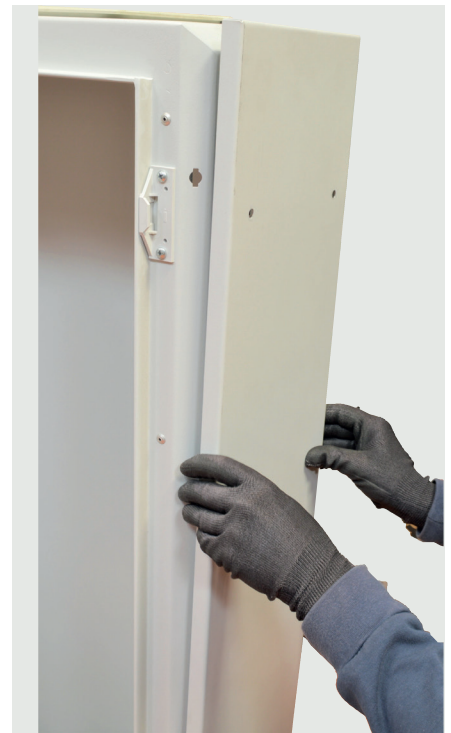

The side panels are supplied in pairs, with their weatherproof seals fitted, and with their fixing screws and plastic blanking plates.



It is essential to fit the blanking plates in the joining holes to ensure IP 55 protection.

2 JOINING THE ENCLOSURES

The enclosures are mechanically linked using joining kits Cat.No 0 204 86. The weatherproof seal is obtained by fitting the self-adhesive seal Cat. No 0 205 85 beforehand.



Attach the seal to the bottom.



A seal must be fitted on each enclosure.

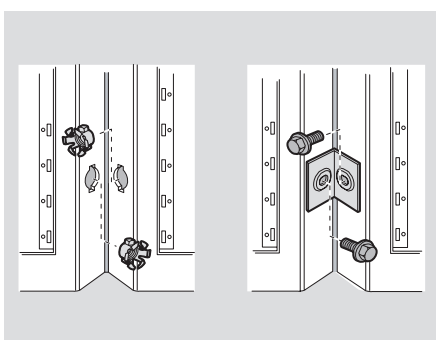

Insert the clip-nuts on the upright then attach the bracket using two M6 screws.

Number of joining kits Cat.No 0 204 86 according to the height of the enclosures

Height	1095	1295	1595	1995
Quantity	2	2	3	4

Usable dimensions of the side opening according to the height of the enclosures

	H	l	h
	1095	128	895
	1295	128	1095
	1595	128	1395
	1995	128	1795

3 ASSEMBLING THE PLINTH

Enclosures and external cable sleeves are supplied with their plinths (height 100 mm).

The plinths are also available separately (Cat.No 0 204 60/61/62, respective widths 700 and 950 mm, and 500 mm for cable sleeve). They can be placed on top of one another to make the enclosures higher.

If enclosures are joined horizontally, a space can be made between the plinths (pre-cut 135 x 65 mm opening on both sides).



The opening is made using a hammer.

ASSEMBLING THE ENCLOSURES

4 MOUNTING AN INTERNAL CABLE SLEEVE

36-module IP 55 cabinets and enclosures can be converted to 24 modules with an internal cable sleeve on the right or the left, using kits Cat.No 204 26/27/28/29.

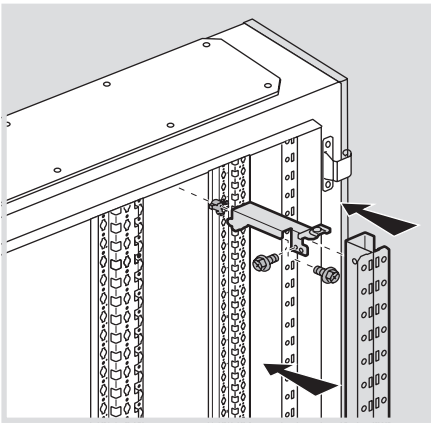

An internal cable sleeve is mounted in exactly the same way as for IP 30 enclosures (see page 12).

5 CABLE GLAND PLATES

The top and bottom of the enclosures are equipped with cable gland plates. These are fixed using self-tapping screws.

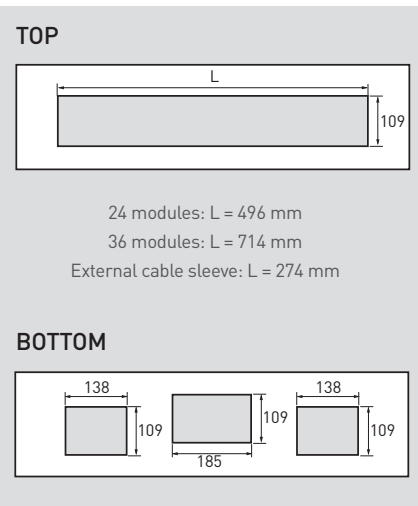

Usable dimensions of the cable feedthroughs (mm).

6 MOUNTING THE DOORS

The enclosures are supplied with the hinges and door releases fitted.

■ **The doors of cabinets (H < 1595 mm) are supplied with two locking handles (to be fitted).**

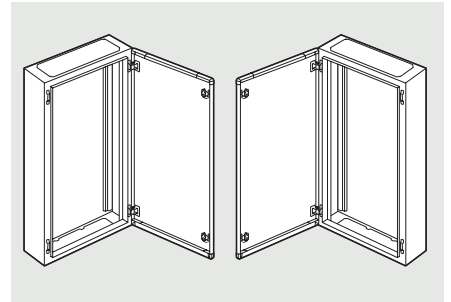

The cabinets are fully reversible: the direction of opening can be changed by simply turning the cabinet upside down or reversing the hinges and door releases.

■ **The doors of the enclosures (H ≥ 1595 mm) are supplied with a connecting rod assembly and a central handle (to be fitted).**

For enclosures the direction of opening is changed by reversing the door: the hinges and door releases are identical. The handles are fitted and reversed in exactly the same way as for IP 30 enclosures (see page 13).



Maximum door opening:

- 125° (XL³ 400/800)
- 130° (XL³ 800 with another enclosure on the hinge side)
- 140° (XL³ 400 IP55/800 IP55 for a single enclosure)

7 DOOR EQUIPOTENTIAL LINK

If control and signalling units whose voltage is higher than 50 V are fitted, it is essential to create the door equipotential link using the integrated stud.



Insert the conductors in the enclosure via a solid faceplate fitted with a cable gland Cat.No 0 919 14 (hole \varnothing 23 mm).

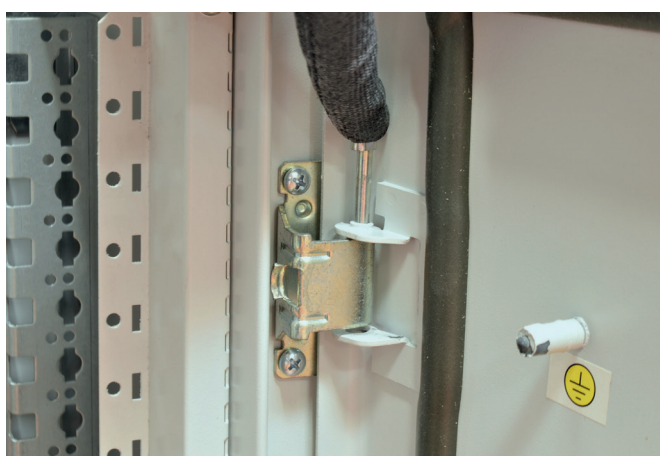

The doors are easy to mount: simply fit the hinge pins.

MOUNTING THE DISTRIBUTION SYSTEMS

Optimised distribution

XL³ 400 and XL³ 800 enclosures give users freedom to organise the distribution. With VX³ busbars and HX³ optimised row distribution blocks, Legrand provides a complete, coherent system for horizontal and vertical distribution. This distribution system increases safety and assists with quick installation and optimisation of the space in the enclosure.

VX³ BUSBARS

BUSBARS AT THE BACK OF ENCLOSURES

POWER SUPPLY KITS

These kits, consisting of prefabricated copper connections, supply the VX³ busbar from the main device.

ISOLATING SUPPORTS

These are fixed at the back of the enclosure on the functional uprights. They take aluminium C-section busbars. The lug supports make it easy to mount the bars. In XL³ 400 enclosures, an insulated backplate is required for mounting the busbar.

TINNED COPPER ALUMINIUM BUSBARS

Their surface treatment ensures electrolytic compatibility with copper and durability of the contacts. Their C-section enables connection without any drilling, using the special hammer head bolts and tap-off terminals.

ISOLATING PROFILES

These ensure IP XXB protection.

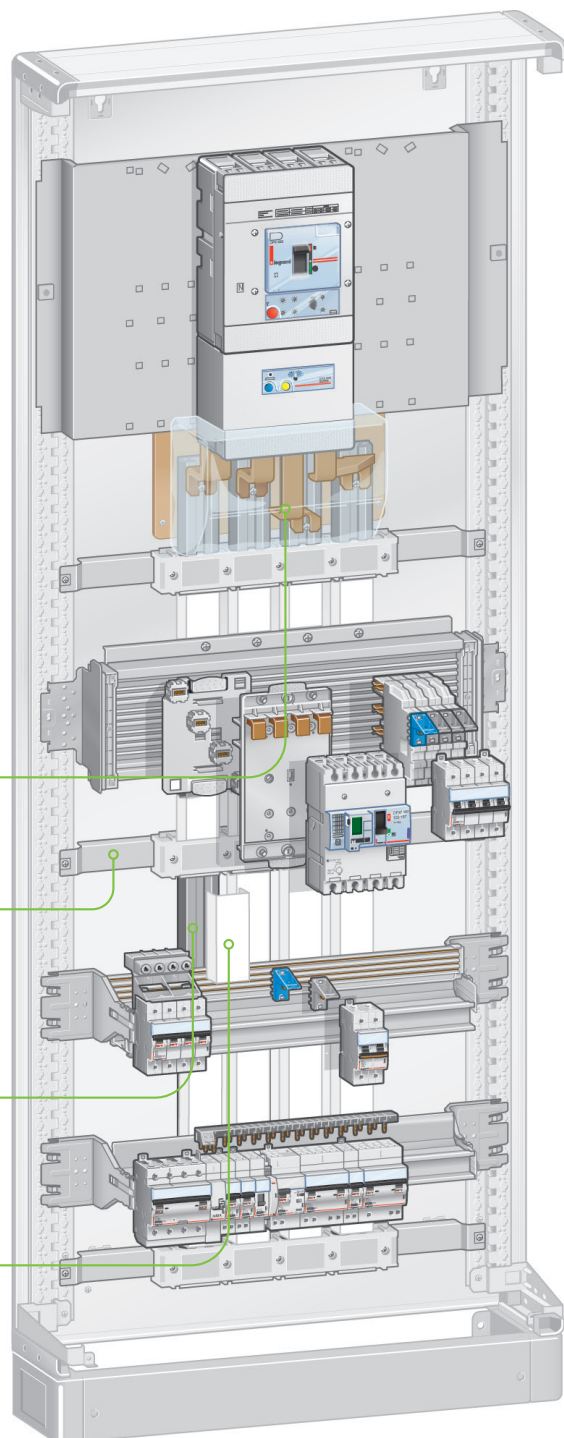

BUSBARS IN CABLE SLEEVES

POWER SUPPLY KITS

These kits, consisting of prefabricated copper connections, supply the VX³ busbar from the main device.

ISOLATING SUPPORTS

These are mounted in cable sleeves on the functional uprights. They take aluminium C-section busbars. The lug supports make it easy to mount the bars.

TINNED COPPER ALUMINIUM BUSBARS

Their surface treatment ensures electrolytic compatibility with copper and durability of the contacts. Their C-section enables connection without any drilling, using the special hammer head bolts and tap-off terminals.

CONNECTION KITS

Prefabricated connections for supplying HX³ 250 and 400 A row distribution blocks and protection devices without any bending or drilling.

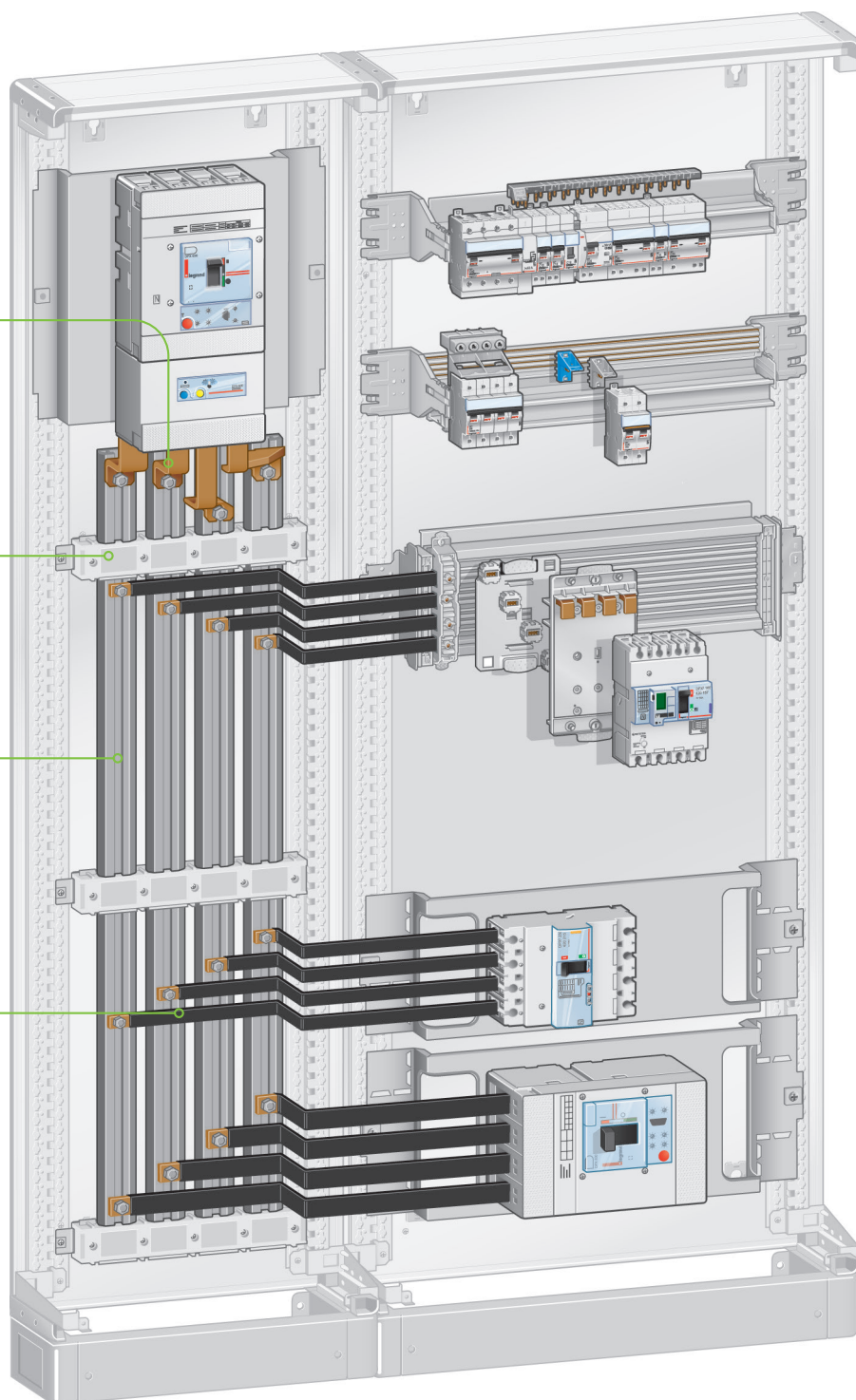

MOUNTING THE DISTRIBUTION SYSTEMS

PRODUCT SELECTION

BUSBAR AT BACK OF XL³ 400/800 ENCLOSURE

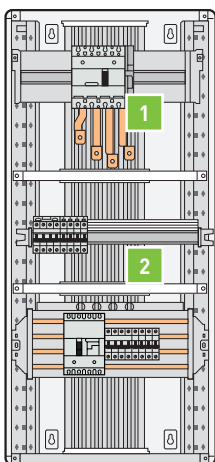

1 POWER SUPPLY KIT (VERTICAL MAIN DEVICE IN ENCLOSURE)						
Enclosure	DPX ³ 160	DPX ³ 250	DPX 630	DPX 1600	DPX-IS 250	DPX-IS 630
XL ³ 400	4 044 40	4 044 41	4 044 42	-	4 044 43	4 044 44
XL ³ 800	-	-	4 044 63	4 044 64	-	4 044 65

2 BUSBARS AT THE BACK OF ENCLOSURE		
Enclosure	XL ³ 400	XL ³ 800
Insulated backplate	4 044 36	-
Isolating support	4 044 37	4 044 60
Isolating lug support	4 044 38	4 044 61
Isolating profiles	4 044 39	4 044 62
Tinned copper aluminium C-section busbars	250 A	4 044 30
	400 A	4 044 31
	800 A	-
Complete 400 A kit: 1 XL ³ 400 enclosure height 1900 mm + 1 insulated backplate + 3 isolating supports + 1 lug support + 4 x 400 A bars + 1 set of IP 2X isolating profiles	4 044 35	-

BUSBAR IN XL³ 400/800 CABLE SLEEVE

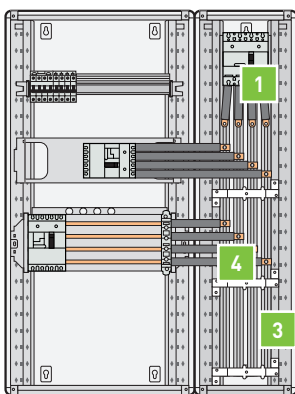

1 POWER SUPPLY KIT (VERTICAL DEVICE IN CABLE SLEEVE)				2 POWER SUPPLY KIT (HORIZONTAL DEVICE IN ENCLOSURE)			
Enclosure	DPX ³ 160	DPX ³ 250	DPX 630	DPX ³ 160	DPX ³ 250	DPX 630	DPX 1600 ⁽¹⁾
XL ³ 400	4 044 52	4 044 53	4 044 54	4 044 57	4 044 55	4 044 58	-
XL ³ 800	-	-	4 044 72	4 044 73	4 044 74	4 044 75	4 044 76

3 BUSBARS IN CABLE SLEEVE		
Enclosure	XL ³ 400	XL ³ 800
Isolating support	4 044 50	4 044 70
Isolating lug support	4 044 51	4 044 71
Tinned copper aluminium C-section busbars	250 A	4 044 30
	400 A	4 044 31
	800 A	-
		4 044 33

4 CONNECTION KIT				
	Device in horizontal position			HX ³ row distribution block with power supply module Cat.No 4 044 82
	DPX ³ 160	DPX ³ 250	DPX 630	
XL ³ 400	4 044 57	4 044 55	4 044 58	4 044 87
XL ³ 800	4 044 73	4 044 74	4 044 75	4 044 86

⁽¹⁾ Limited to 800 A

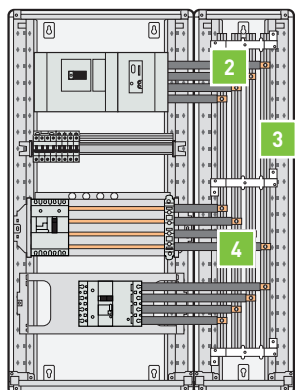

HX³ ROW DISTRIBUTION BLOCKS

HX³ 250 AND 400 A 4-POLE DISTRIBUTION BLOCKS

The distribution block can be supplied directly via a VX³ busbar (with or without connection accessories, depending on the configuration) or via a head of row device.

- Rated voltage (U_e): 230/400 V \sim
- Rated frequency: 50/60 Hz
- Permissible short-circuit current (I_{pk}): 52 kA
- Insulation voltage (U_i): 1000 V
- Rated current: 250/400 A maximum (central power supply)
- Protection index: IP 20
- Maximum connection cross-section for the power supply module: flexible bars 32 x 4 mm

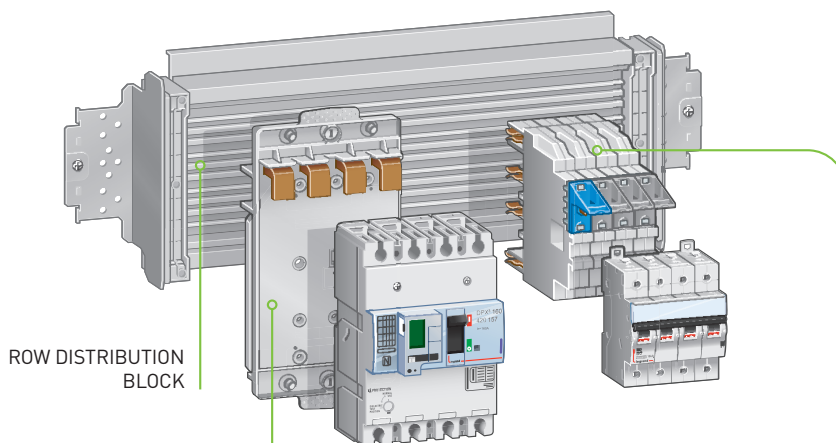

ROW DISTRIBUTION BLOCK

SUPPORT BASES FOR DPX³ CIRCUIT BREAKERS
For fixing and connecting 3P and 4P DPX³ 160 and 250 circuit breakers and RCB0s.

SUPPORT BASES FOR MODULAR DEVICES
For fixing and connecting 1P, 2P, 3P and 4P DX³ 1 module/pole and 1.5 module/pole circuit breakers. A 1-module universal support base (without connections) is used to insert control devices in the row.

HX³ 80 AND 125 A PLUG-IN 4-POLE DISTRIBUTION BLOCKS

Tool-free installation on 2-position aluminium \sqcup rails.

- Rated voltage (U_e): 230/400 V \sim
- Rated frequency: 50/60 Hz
- Permissible short-circuit current (I_{pk}): 25 kA
- Insulation voltage (U_i): 690 V \sim
- Rated current:
 - 125 A maximum, direct connection on power supply module
 - 80 A maximum, direct connection on modular device
- Protection index: IP 20
- Maximum connection cross-section of power supply module: 50 mm

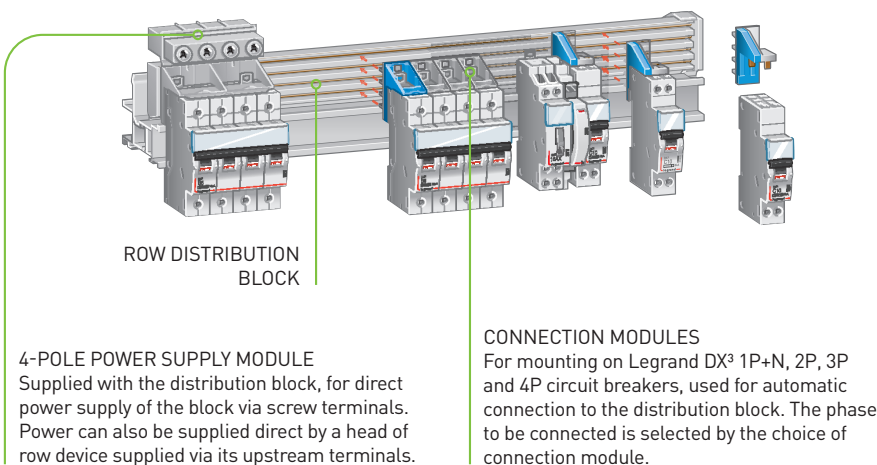

ROW DISTRIBUTION BLOCK

4-POLE POWER SUPPLY MODULE
Supplied with the distribution block, for direct power supply of the block via screw terminals. Power can also be supplied direct by a head of row device supplied via its upstream terminals.

CONNECTION MODULES
For mounting on Legrand DX³ 1P+N, 2P, 3P and 4P circuit breakers, used for automatic connection to the distribution block. The phase to be connected is selected by the choice of connection module.

HX³ AND VX³ DISTRIBUTION BLOCKS WITH AUTOMATIC TERMINALS

HX³ and VX³ distribution blocks with automatic terminals are used for the vertical power supply and horizontal distribution of modular rows. These distribution blocks are designed to provide IP XXB protection.



VX³ 125 A AUTOMATIC

- Rated voltage (U_e): 230/400 V \sim
- Rated frequency: 50/60 Hz
- Permissible short-circuit current (I_{pk}): 30 kA
- Insulation voltage (U_i): 500 V \sim
- Protection index: IP 20

HX³ 125 A AUTOMATIC

- Rated voltage (U_e): 230/400 V \sim
- Rated frequency: 50/60 Hz
- Permissible short-circuit current (I_{pk}): 20 kA
- Insulation voltage (U_i): 500 V \sim
- Impulse voltage U_{imp}: 6 kV - degree of pollution 3
- Rated current: 125 A
- Protection index: IP 20

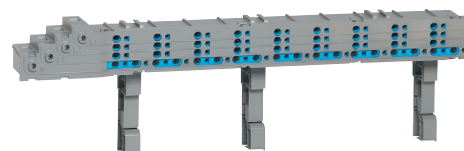

MOUNTING VX³ BUSBARS AT THE BACK OF THE ENCLOSURE

Optimised distribution at the back of the enclosure is created using aluminium C-section busbars equipped with an insulated backplate for XL³ 400 or isolating profiles for XL³ 800. These are all held in place by supports.

MAXIMUM DISTANCES BETWEEN SUPPORTS ACCORDING TO THE PEAK CURRENT

In XL ³ 400 enclosure (supports Cat.No 4 044 37/38, busbars Cat.No 4 044 30/31)		
I _{pk} (kA)	I _{cw} (kA)	D (mm)
7	5	1600
17	10	1600
30	15	1000
40	20	800
52	25	600

In XL ³ 800 enclosure (supports Cat.No 4 044 60/61, busbars Cat.No 4 044 33)		
I _{pk} (kA)	I _{cw} (kA)	D (mm)
30	15	1600
40	20	1000
52	25	800
63	30	700
73	35	600
84	40	500
94	45	400
105	50	400

1 MOUNTING THE BUSBAR

■ In XL³ 400



Fit the lug support Cat.No 4 044 38 at the back of the enclosure.



Supports Cat.No 4 044 37/38 have markings, for ease of installation. The bottom of the enclosure is indicated by an arrow.



Place the insulated backplate Cat.No 4 044 36 and the aluminium C-section bars in position.



■ In XL³ 800

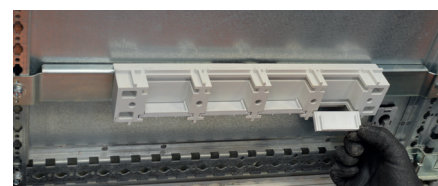

Fix the lug support Cat.No 4 044 61 at the back of the enclosure and insert the spacers on which the busbars will be supported.

2 SUPPLYING THE BUSBAR

The prefabricated power supply kits save time and are easy to mount for the various different main devices.



Screw in the front of the lug support but do not fully tighten the screws.



Screw in the front of the supports to hold the busbars firmly in place. Do not forget to fully tighten the screws on the lug support.

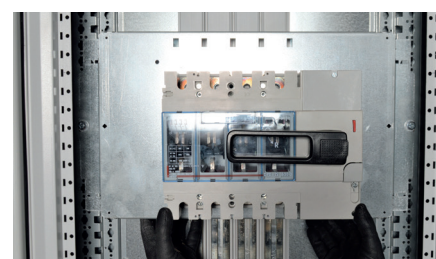

Position the main device on its plate.

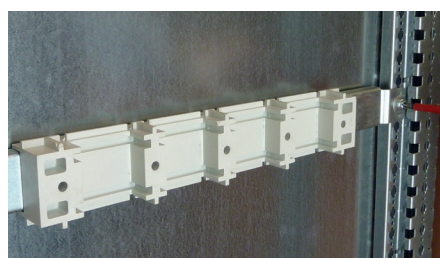

Install the intermediate supports Cat. No 4 044 60 without fitting the front.



IPXXB protection is obtained by installing the isolating profiles Cat.No 4 044 62 on aluminium C-section busbars.



The kits are connected on the busbar using the hammer head bolts supplied with the kits.



Position the aluminium C-section busbars so that they are supported on the lug support.

i For the maximum distances between supports, refer to the table on the previous page and to the instructions for the busbar supports.

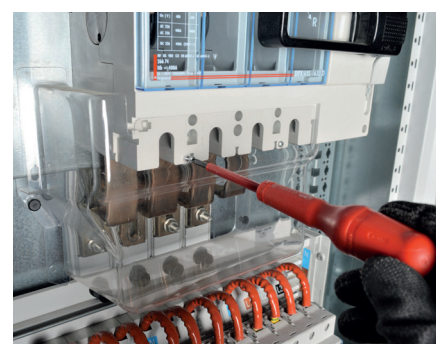

Fit the IPXXB protective cover supplied with the kit.

MOUNTING THE DISTRIBUTION SYSTEMS

3 MOUNTING HX³ 250 AND 400 A ROW DISTRIBUTION BLOCKS

The HX³ row distribution block takes the bases for DPX³ and DX³.

There are two catalogue numbers for mounting on busbars at the back of the enclosure, depending on the type of enclosure:

XL³ 400: HX³ 250 A row distribution block
Cat.No 4 044 80

XL³ 800: HX³ row 400 A distribution block
Cat.No 4 044 83



i For vertical positioning of the distribution block in the enclosure, see page 52.



The row distribution blocks are pre-equipped with hammer head bolts. Tighten them to connect the block to the busbar.

! Do not forget to fit the isolating profiles on the busbars for IP XXB protection.



Insert the screw covers fully to provide IP XXB protection.

i For the installation of devices on the distribution block, see page 34.

4 TAP-OFF TERMINALS

All other types of devices with currents $I \leq 250$ A must be connected to the busbar by IP 2X tap-off terminals Cat.No 4 044 90 (400 A busbars) or Cat.No 4 044 89 (800 A busbars).



Tightening torque 20 Nm



This terminal is used for connecting two conductors and provides IP XXB protection with the screw cover inserted.

MOUNTING VX³ BUSBARS IN CABLE SLEEVES

This type of optimised distribution consists of equipping the cable sleeve with aluminium C-section busbars, all held in place by supports.

MAXIMUM DISTANCES BETWEEN SUPPORTS ACCORDING TO THE PEAK CURRENT

In XL ³ 400 enclosure (supports Cat.No 4 044 50/51)			
I _{pk} (kA)	I _{cw} (kA)	D (mm) dep. on bar Cat. No.	
		4 044 30	4 044 31
10	6	1600	1600
21	11	800	800
30	15	400	500
40	20	350	400
52	25	250	300

In XL ³ 800 enclosure (supports Cat.No 4 044 60/61, busbars Cat.No 4 044 33)		
I _{pk} (kA)	I _{cw} (kA)	D (mm)
30	15	1600
40	20	1000
52	25	800
63	30	700
73	35	600
84	40	600
94	45	500
105	50	500

1 MOUNTING THE BUSBAR

Isolating supports are used to create a staggered busbar at the back of external cable sleeves (up to 800 A) or internal cable sleeves (up to 400 A).



Attach the lug support Cat.No 4 044 51 (XL³ 400) or Cat.No 4 044 71 (XL³ 800) to the bottom of the uprights in the cable sleeve using clip-nuts and M6 screws.



Position the lugs in each compartment.

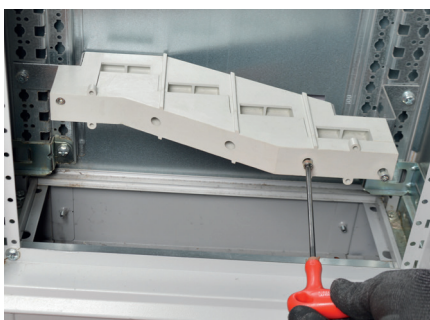

Fit the front of the support but do not fully tighten the screws.

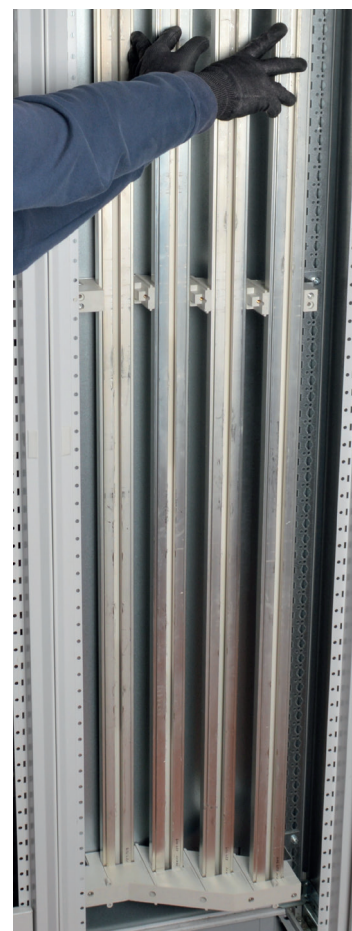

Then fit the other isolating supports Cat.No 4 044 50 (XL³ 400) or Cat.No 4 044 70 (XL³ 800), then position the aluminium C-section busbars.



Tighten the screws on the front of the support (tightening torque 6 Nm).



Do not forget to tighten the lug support fully.

MOUNTING THE DISTRIBUTION SYSTEMS

2 CONNECTING THE MAIN DEVICE

The main device can be mounted in the cable sleeve or in the enclosure.

■ Main device mounted in cable sleeve

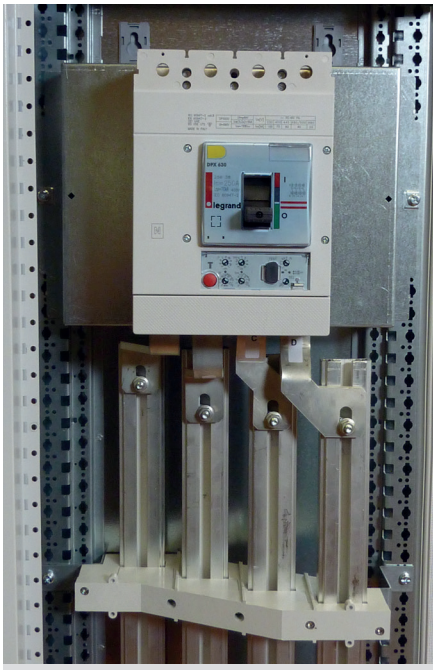

The principle is the same as for distribution at the back of the enclosure (see page 29). The device is fixed on its plate and mounted in the cable sleeve. Then use the special prefabricated connection kits to connect it to the busbar.

■ Main device mounted in enclosure



In this type of mounting, the main device will be positioned horizontally in the enclosure and will be connected to the busbar using the special prefabricated kit. Once the main device has been mounted in the enclosure, connect the various bars in the connection kit to the busbar.



It will be necessary to cut some of the bars in the kit in order to connect them correctly, depending on the position of the cable sleeve (right or left). To do this, pre-position the bars in order to identify the mark indicating where to cut.



Strip a sufficient length. You can use the part that has been cut off as a reference.



Cut the bar at the mark.



As the busbars are predrilled, all you have to do is connect the main device to the busbar using hammer head nuts.

3 CONNECTING THE OUTGOING LINE PROTECTION DEVICES

The principle is the same as for connecting the main device.

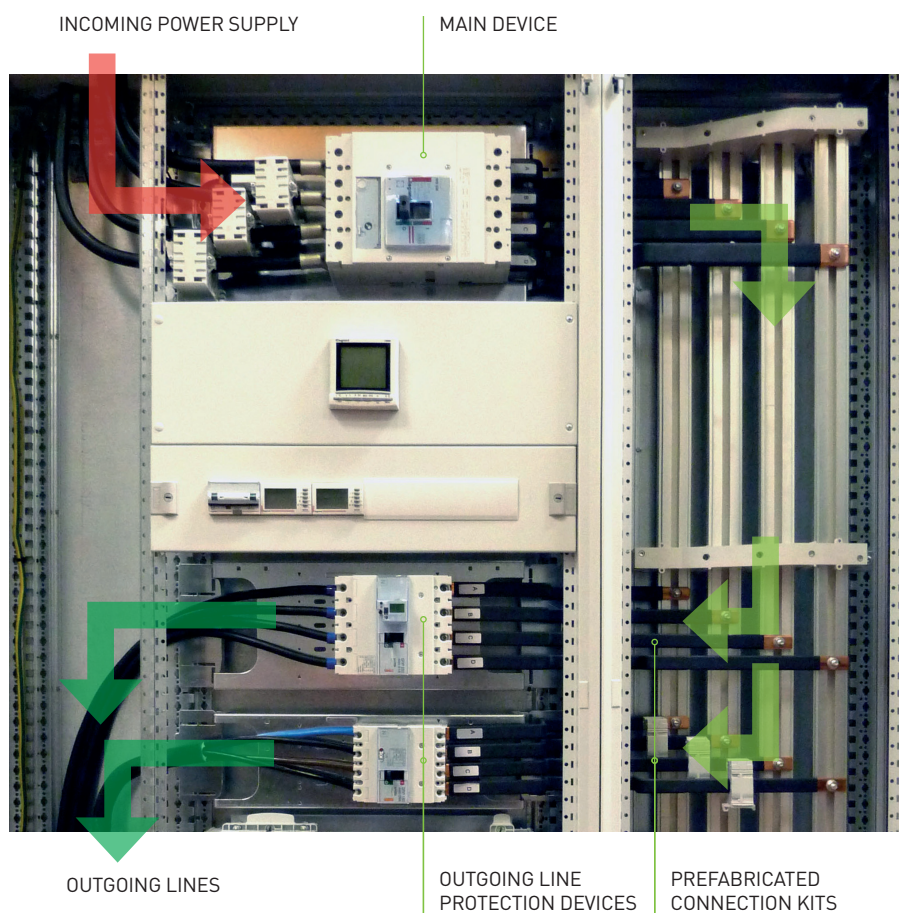

4 MOUNTING HX³ 250/400 A ROW DISTRIBUTION BLOCKS

The HX³ row distribution block takes the bases for DPX³ and DX³.

There are two catalogue numbers for mounting in an enclosure with power supply in a cable sleeve, depending on the type of enclosure:

- XL³ 400: HX³ 250 A row distribution block – Cat.No 4 044 81
- XL³ 800: HX³ 400 A row distribution block – Cat.No 4 044 84



Position the row distribution block and fix it on the functional uprights of the enclosure.

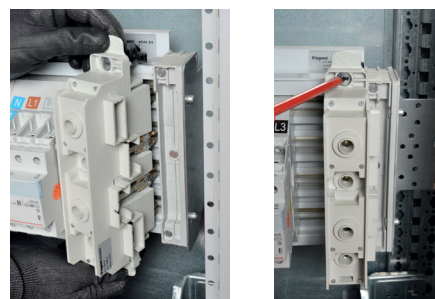

Position and lock the side-mounting power supply module for the row distribution block (Cat.No 4 044 82) on the side of the cable sleeve on which the busbar is located.



Then connect the power supply module to the busbar using the prefabricated connection kit.

XL³ 400: Kit for HX³ 250 A row distribution block – Cat.No 4 044 87

XL³ 800: Kit for HX³ 400 A row distribution block – Cat.No 4 044 86

As for the other devices, it will be necessary to cut some of the bars in the kit in order to connect them correctly, depending on the position of the cable sleeve (right or left) [see page 32].

MOUNTING THE DISTRIBUTION SYSTEMS

EQUIPPING HX³ 250 AND 400 A ROW DISTRIBUTION BLOCKS

1 MOUNTING A DPX³

Circuit breakers are mounted on the HX³ distribution block using support bases. The four support bases for DPX³ enable 3P and 4P DPX³ 160 and DPX³ 250 A circuit breakers to be connected automatically.

Support bases for DPX ³		
Device	DPX ³ 160	DPX ³ 250
3P	4 045 00	4 045 02
4P	4 045 01	4 045 03

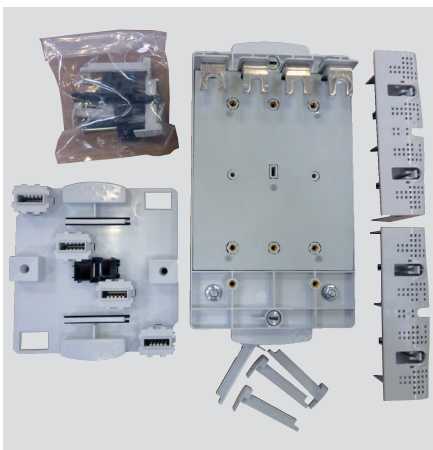

Support bases for DPX³ consist of a fixed part, a movable part, an anti-withdrawal kit and two terminal shields. They enable a DPX³ 160 or 250 (when off-load) to be connected automatically to the row distribution block while energised.

! When mounting a DPX³ 160, the upstream cage terminals must first be removed from the device.

A) MOUNTING THE CIRCUIT BREAKER ON THE BASE



Install the movable part of the base, inserting the conductive parts into the upstream terminals of the DPX³ circuit breaker.

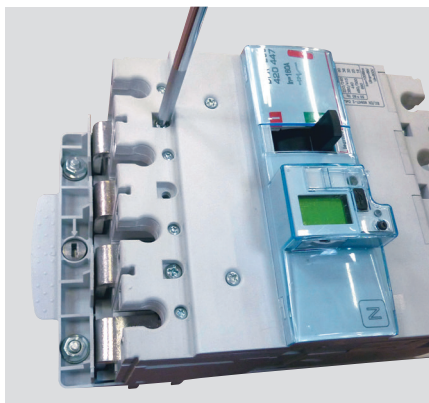

Secure the device to the base using the fixing screws supplied with the DPX³.



Make the upstream electrical connections with the screws supplied with the circuit breaker (no. 4 Allen key, tightening torque 7 N·m).

B) INSTALLING THE ANTI-WITHDRAWAL KIT

The anti-withdrawal kit prevents a circuit breaker being withdrawn in the closed position.



Insert the spring...



...then assemble the two parts of the kit.

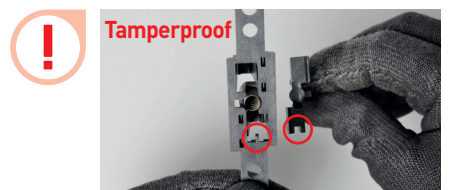

Tamperproof

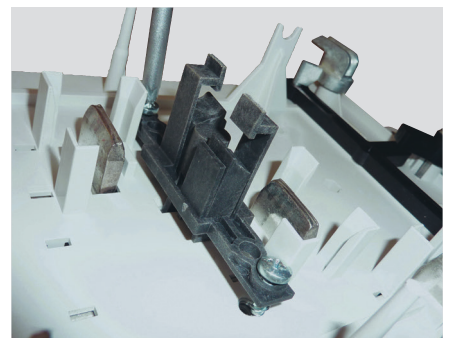

Fix the kit on the back of the movable part of the support base with the two screws supplied (tightening torque 1 N·m).

C) FITTING THE TERMINAL SHIELDS



Engage the rear part of the terminal shield then push it down at the front.



Lock the terminal shield by inserting the 2 sealed plugs.



For downstream connection of the DPX³, the downstream terminal shield must be removed.

D) MOUNTING THE DPX³ ON THE DISTRIBUTION BLOCK

The DPX³ equipped with a support base can be installed on the 400 A row distribution block while energised.



Position the fixed part of the support base on the row distribution block.



It is locked automatically.



Clip the DPX³ on this base in open position.



Lock the assembly with the top and bottom ¼ turn screws.

MOUNTING THE DISTRIBUTION SYSTEMS

2 MOUNTING DX³ CIRCUIT BREAKERS

Installing modular circuit breakers on the HX³ 400 A distribution block requires the use of support bases for DX³. They raise modular circuit breakers to the same height as DPX³, so that they can be installed together on the same row.

A) MOUNTING DX³ ON WIRED BASE

This type of base is used to connect modular devices with screw terminals and either 1 or 1.5 modules per pole, depending on the catalogue number chosen. The circuit breakers do not require any preparation.



Connect the wires in the circuit breaker without installing it on the "rail" part of the support base.

Engage the device in the same way as on a standard modular rail.

Recommended tightening torque:
2.5 N·m for DX³ with 1 module/pole
5.5 N·m. for DX³ with 1.5 module/pole

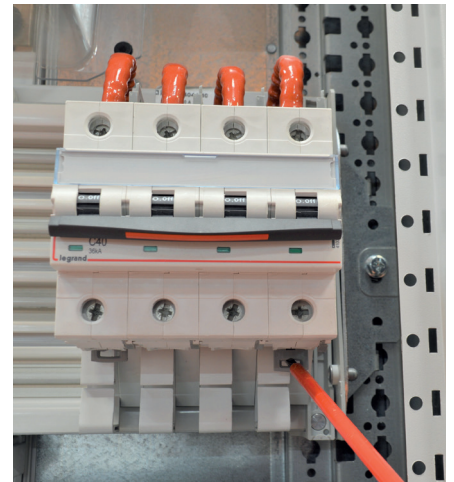

Complete the installation by locking the circuit breaker clips.

Wired bases for DX ³			
Device	Connection	1 mod/ pole	1.5 mod/ pole
1P	L1	4 045 24	4 045 18
	L2	4 045 25	4 045 19
	L3	4 045 26	4 045 20
	N	4 045 23	4 045 17
3P	L1, L2, L3	4 045 22	4 045 16
4P	L1, L2, L3, N	4 045 21	4 045 15

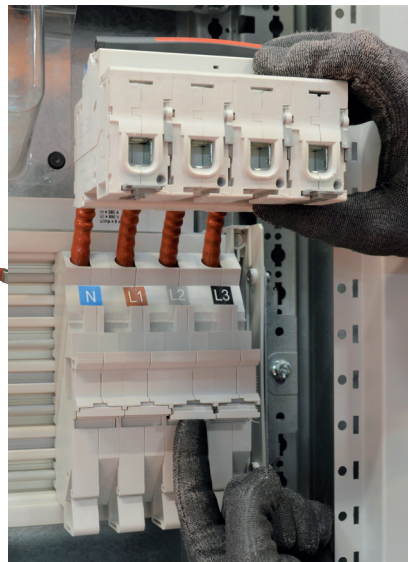
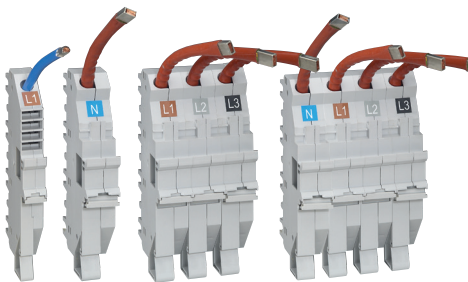

Holding the circuit breaker with one hand, clip the base onto the distribution block and lock it using the locking levers.

! To prevent any risk of contact with live parts, the wires must be connected to the circuit breaker before the base is installed on the distribution block.

DX ³ devices compatible with modular bases		
Devices	Plug-in bases	Wired bases
2P and 4P DX ³ -ID RCCBs – outgoing lines via the bottom	•	•
2P and 4P DX ³ RCBOs – protection of outgoing lines	•	•
1P, 2P, 3P and 4P DX ³ circuit breakers – 1 module/pole	•	•
1P, 2P, 3P and 4P DX ³ circuit breakers – 1.5 modules/pole		•

3 INSTALLING SUPPORT BASES FOR DX³

A) MOUNTING DX³ CIRCUIT BREAKERS ON PLUG-IN BASE

Plug-in (wireless) bases for DX³ are intended for devices with 1 module per pole which are connected via the rear of the circuit breaker.

Plug-in bases for DX ³		
Device	Connection	1 mod/pole
1P	L1	4 045 10
	L2	4 045 11
	L3	4 045 12
	N	4 045 13
3P	L1, L2, L3	4 045 09
4P	L1, L2, L3, N	4 045 08



The plug-in bases are supplied with the corresponding connection modules which must be installed first on the circuit breakers.

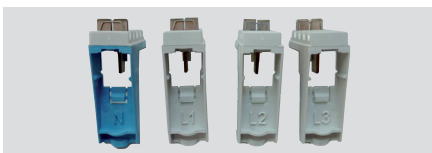

There are four colours of connection module corresponding to the four poles on the row distribution block.

Blue	L1	L2	L3
Neutral	Phase 1	Phase 2	Phase 3

This enables the required phase to be selected. It is thus very easy to balance the phases on the whole row.

The connection module is mounted via the rear of the circuit breaker.



Position the upper part of the connection module (marked "Max 80") on the top of the circuit breaker then push it forward to engage the module pin in the device's plug-in mechanism. This mechanism ensures the contact pressure is correct. Then do the same for the other poles.

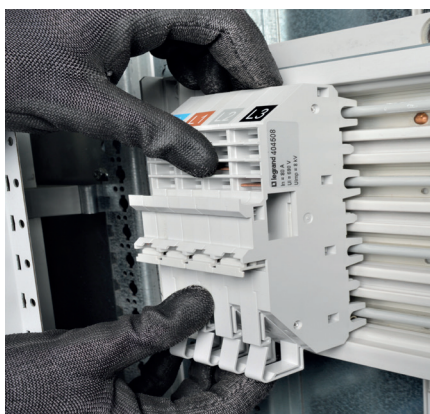

Clip the base on the distribution block...



... then lock the assembly using the levers.

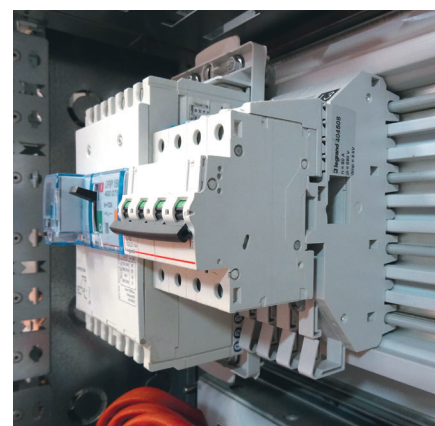

Then push on the circuit breaker to clip it onto the base, and lock it with the clips. Further circuit breakers can be added while energised but off-load (circuit breaker in open position).

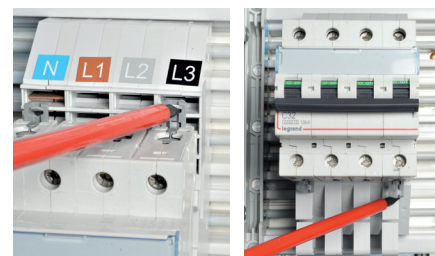

The circuit breaker is correctly installed once it is locked on the rail.

MOUNTING THE DISTRIBUTION SYSTEMS

MOUNTING HX³ PLUG-IN DISTRIBUTION BLOCKS

The HX³ plug-in row distribution block is used for 4-pole distribution of DX³ devices (1 module per pole) up to 80 A by direct connection to a circuit breaker or 125 A with the power supply module.

With its IPXXB insulation, devices can be safely connected and disconnected automatically while the block is energised. Like the 250 or 400 A row distribution blocks, it provides total freedom to combine 1P+N, 1P, 2P, 3P and 4P DX³.

It is mounted in XL³ 400 and XL³ 800 enclosures in the same way.

HX³ plug-in 24 modules – Cat.No 4 052 40

HX³ plug-in 36 modules – Cat.No 4 052 41

125 A power supply module for HX³ plug-in – Cat.No 4 052 42

! Connection and disconnection of circuit breakers not serving as the power supply to the distribution block can be done when voltage is present. However, the circuit must be off load (circuit breaker open).

UP TO 80 A

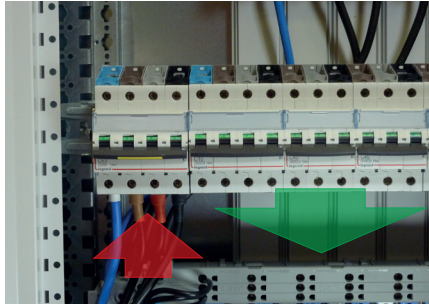

Indirect power supply of the distribution block via a "head of row" device

UP TO 125 A

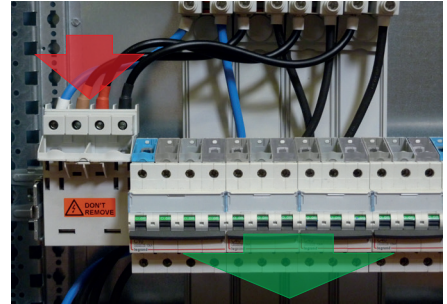

Direct power supply of the distribution block via power supply module Cat.No 4 052 42 fitted with its protective cover

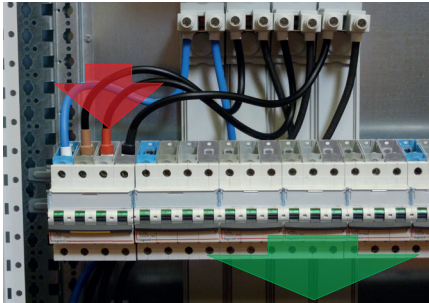

Direct power supply of the distribution block via the terminals of one of the devices

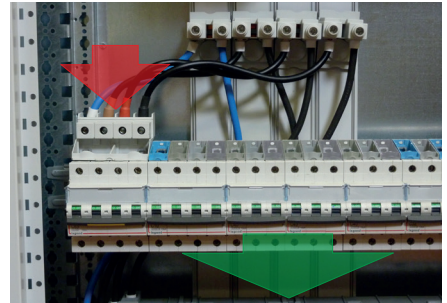

Direct power supply of the distribution block via power supply module Cat.No 4 052 42 equipped with a device

1 INSTALLING THE DISTRIBUTION BLOCK IN THE ENCLOSURE

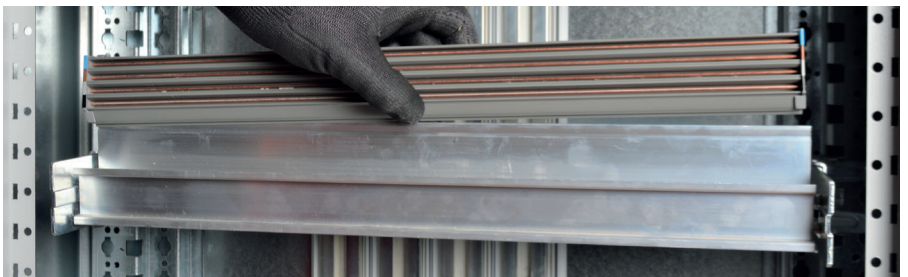

The HX³ plug-in distribution block is mounted directly on rails Cat.No 0 202 01 /06/51 by simply clipping it on.



Position the rail in the enclosure in the up or down position.

2 FITTING THE CONNECTION MODULES

■ 1P+N devices- 1 module



For 1P+N circuit breakers with **automatic terminals**, the connection module can be installed without any tools, simply by pressing down on it.



For 1P+N circuit breakers with **screw terminals**, the device's terminals must first be opened with a PZ screwdriver.

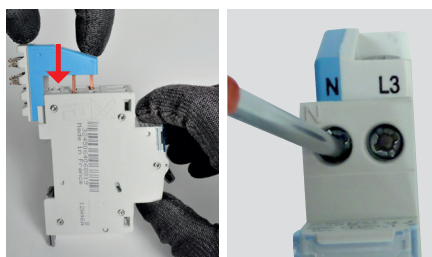

Install the module in the same way as on automatic terminals so that the connection module's teeth are inserted in the circuit breaker terminals, then tighten to the correct torque (1.6 to 2 N·m).

■ Devices with 1 module per pole

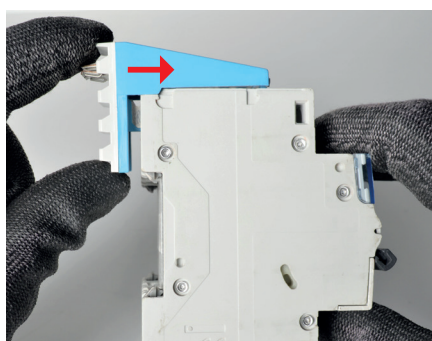

These are mounted in the same way as 250 and 400 A row distribution blocks (see page 37).

3 DISTRIBUTION BLOCK POWER SUPPLY

■ Connection to the power supply module (up to 125 A)

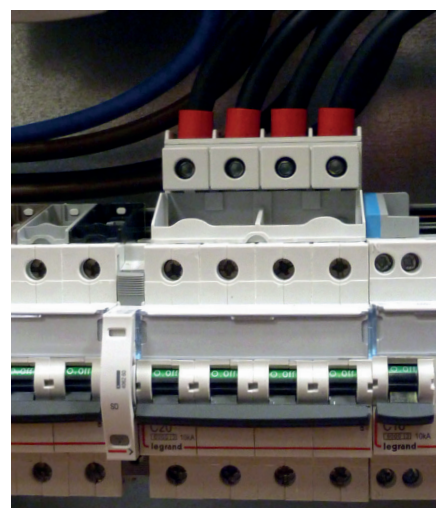

Cables up to 35 mm² can be connected to the power supply module. When its protective cover is removed, it can take a 4-pole device.

When the power supply module is equipped with a device, this device must never be removed while energised.

■ Connection to the terminals of a device (up to 80 A)

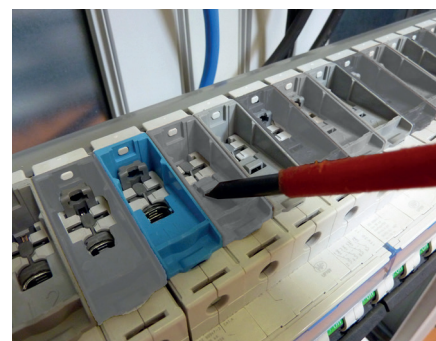

To supply the distribution block directly via the terminals of one of the devices, first break off the protective tabs on the connection modules.

Compatible modular devices	Connection modules
1P+N DNX ³ circuit breakers – 1 module – screw or automatic terminals	4 052 22 (L1N, L2N, L3N)
1P+N DX ³ RCBOs – protection of outgoing lines	
2P and 4P DX ³ -ID RCCBs – incoming via the top/outgoing via the bottom	
2P and 4P DX ³ RCBOs – protection of outgoing lines	4 052 23 (L1, L2, L3, N)
1P, 2P, 3P and 4P DX ³ circuit breakers – 1 module/pole	

MOUNTING THE DISTRIBUTION SYSTEMS

MOUNTING HX³ AND VX³ DISTRIBUTION BLOCKS WITH AUTOMATIC TERMINALS

VX³ and HX³ distribution blocks with automatic terminals are used for the vertical power supply and horizontal distribution of modular rows. These distribution blocks are designed to provide IP XXB protection. HX³ 125 A auto. term. - 1 row: Cat.No 4 052 30 HX³ 125 A auto. term. - 1/2 row: Cat.No 4 052 31 VX³ 125 A auto. term. - 4 rows: Cat.No 4 050 34 VX³ 125 A auto. term. - 5 rows: Cat.No 4 050 35 VX³ 125 A auto. term. - 6 rows: Cat.No 4 050 36.

1 MOUNTING A 125 A HX³ WITH AUTOMATIC TERMINALS

HX³ distribution blocks are supplied with supports for mounting on rails. Cat.No 0 202 06, 0 206 01 and 0 206 51.



Position the supports on the bottom of the distribution block and clip them on.

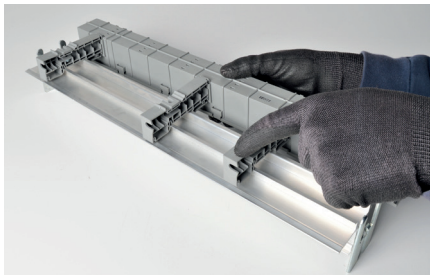

Position the distribution block on the rear of the rail and clip it on.

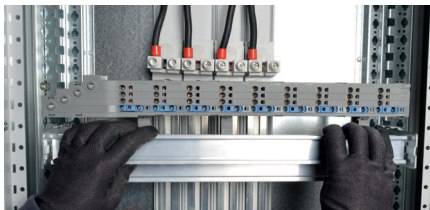

Mount the assembly in the enclosure.

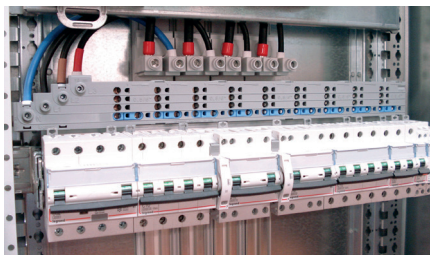

All that remains is to connect the power supply of the distribution block then connect the various outgoing lines.



Power supply from one row to another is obtained by breaking the blanking plates located under the connection terminals.



Strip back the cables 20 mm, and insert them in the terminals of the first distribution block.

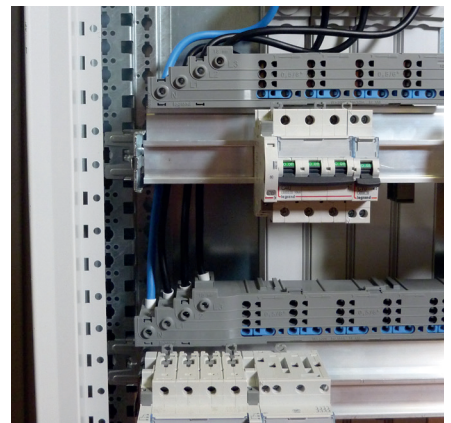

Tighten the terminals of the first distribution block then connect the second block (tightening torque 3 Nm).

2 MOUNTING A 125 A VX³ WITH AUTOMATIC TERMINALS

VX³ distribution blocks are fixed on the functional uprights of the XL³ 400 enclosure. They can be mounted on the right or the left.



Position the supports on the rear of the VX³ distribution block and screw them on.



Fix the assembly on the uprights of the enclosure using clip nuts that have been fitted beforehand.



All that remains is to connect the power supply of the distribution block then connect the various outgoing lines.



To maintain IP XXB protection, it is essential to fit the protective covers on any unused power supply terminals. These terminals will be used when power is supplied from one distribution block to another.

3 CONNECTING THE OUTGOING LINES

Whether the HX³ or the VX³ automatic terminal distribution block is used, as the lines are connected via automatic terminals, simply use a screwdriver as a lever and insert the cable then remove the screwdriver. Lines are disconnected in the same way.

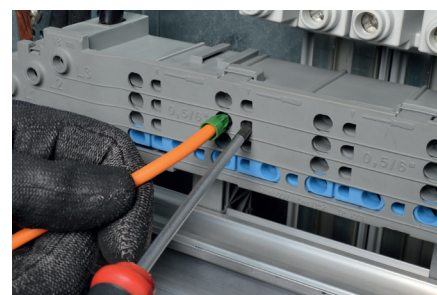

! Caution: lines must not be connected or disconnected while the distribution block is energised. It is essential to switch off the power supply to the distribution blocks before carrying out any work.

Standard distribution

STANDARD DISTRIBUTION AT THE BACK OF THE ENCLOSURE

Standard distribution at the back of the enclosure can be created using vertical busbars with isolating supports Cat.No 0 373 15, or distribution blocks, with stepped distribution block Cat.No 0 373 08 installed horizontally or extra-flat distribution block Cat.No 0 374 00.

1 MOUNTING THE VERTICAL BUSBAR

Support Cat.No 0 373 15 is used for creating busbars up to 400 A at the back of XL³ 400 and 800 cabinets and enclosures.

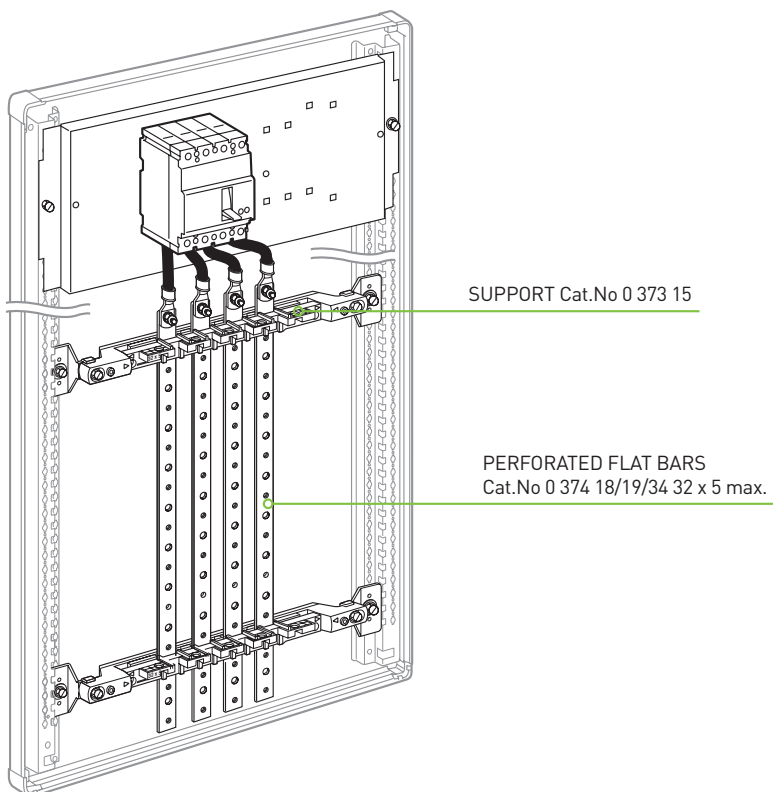

Selection of bars			
Bars	Cross-section (mm)	I (A)	
		IP ≥ 30	IP > 30
0 373 34	18 x 4	250	200
0 373 18	25 x 5	330	270
0 373 19	32 x 5	450	400

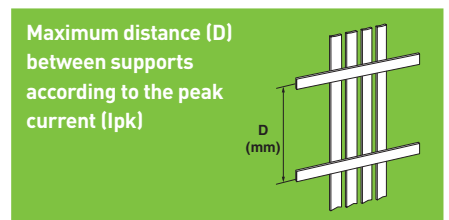

Bars	0 374 34 (18 x 4)	0 374 18 (25 x 5)	0 374 19 (32 x 5)	
Peak Isc Ipk (kÂ)	10	1000	1200	1500
	15	700	1000	1200
	20	550	750	950
	25	400	600	750
	30	350	500	650
	40	250	350	450
	50	200	300	400
	60	200	250	300



XL³ 400

Start by fitting the 2 support retaining lugs on the bottom of the functional uprights using the clip-nuts and M6 screws provided.



XL³ 400

Fix the isolating support on the 2 lugs using the two remaining M6 screws

Extension pieces Cat.No 0 373 14 must be used for mounting in the XL³ 800.



XL³ 800

Mounting on the bottom of the uprights for more space for connecting devices on the busbar.

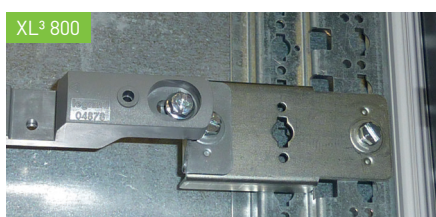

XL³ 800

Mounting on the bottom of the uprights for more space below the busbar and to allow insertion of cables.

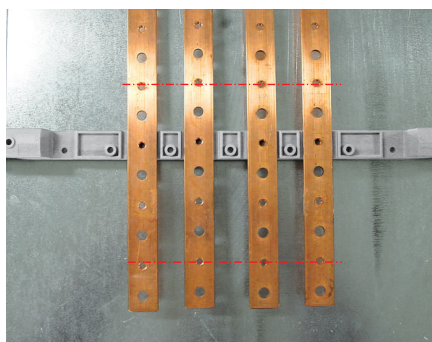

Cut your bars to the required length and place them on the isolating supports, aligning them with the fixing holes.

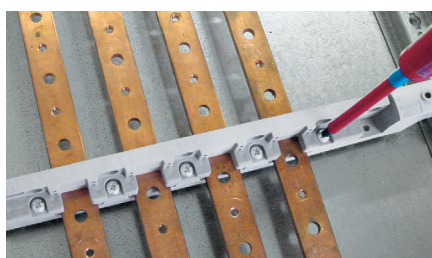

Once the correct position has been determined, fix the retaining crosspiece on the support with the 5 cheese head screws. Do not tighten these screws fully as the positions of the bars may be subsequently adjusted.

■ 3 bar cross-sections on the same support

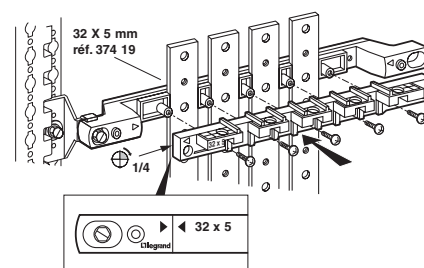

Bars 32 x 5

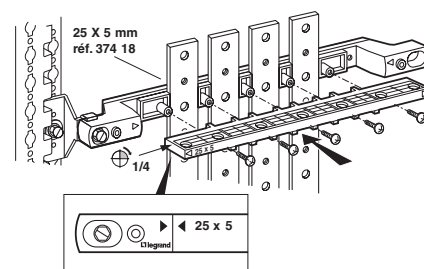

Bars 25 x 5

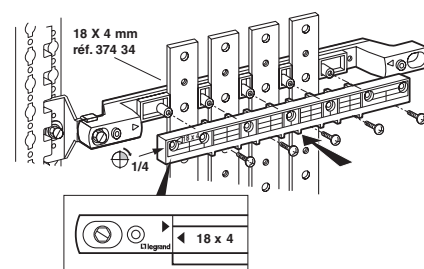

Bars 18 x 4

MOUNTING THE DISTRIBUTION SYSTEMS

2 MOUNTING THE 400 A STEPPED DISTRIBUTION BLOCK CAT.NO 0 373 08 HORIZONTALLY

The 400 A stepped distribution block Cat.No 0 373 08 consists of two isolating supports, four 32 x 4 mm tinned copper bars with protective cover and a protective screen. Each bar has 2 x Ø 8.5 mm smooth holes and 21 tapped holes with M6 screws for connection via terminals (70 mm² max.).

Four insulated lugs are supplied for mounting the distribution block horizontally in XL³ 400 cabinets and enclosures.



Install the 4 fixing lugs on the distribution block.

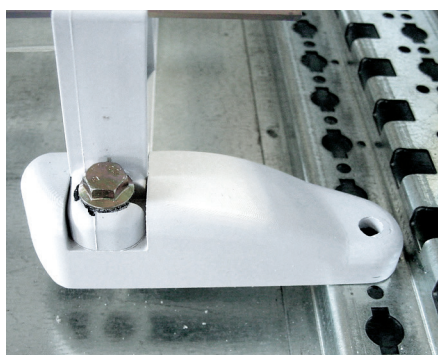

Fit the distribution block on the bottom profile of the functional uprights using clip-nuts and M6 screws.

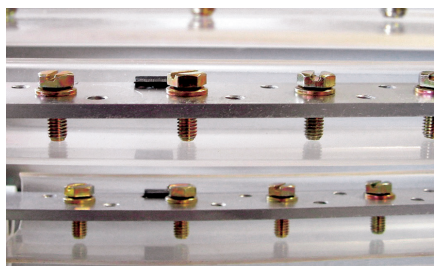

The protective covers are fitted on each bar using staples

In 24-module XL³ 800 enclosures, the distribution block is fixed horizontally on solid plate Cat.No 0 206 46 (height 400 mm) used with solid faceplate Cat.No 0 208 45 or Cat.No 0 209 45.

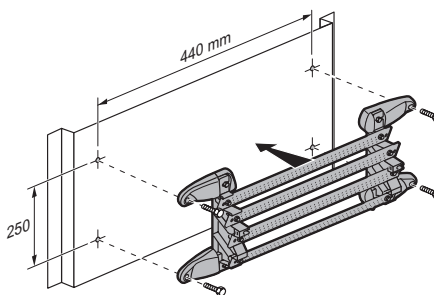

Fixing centres of distribution block Cat.No 0 373 08.

3 MOUNTING THE 250 A EXTRA-FLAT DISTRIBUTION BLOCK CAT.NO 0 374 00 IN XL³ 400

As the extra-flat distribution block has very high short-circuit resistance (60 kA) it can be installed at the supply end of the panel. It can be installed next to a DPX 250 or 630 on fixing plate Cat.No 0 202 20. Connections on plates, incoming: 150 mm² per pole, outgoing: up to 3 x 70 mm² per pole.

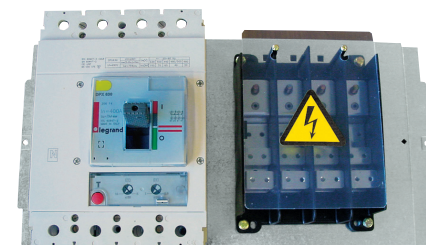
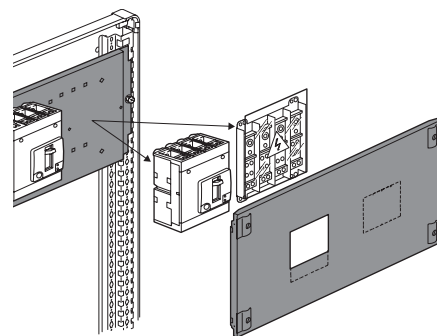

Distribution block Cat.No 0 374 00 saves a considerable amount of space in small cabinets.

STANDARD DISTRIBUTION IN CABLE SLEEVES

1 MOUNTING A STEPPED BUSBAR

Isolating supports Cat.No 0 373 10 are used to create a stepped busbar up to 400 A in an internal cable sleeve (XL³ 800) or external cable sleeve (XL³ 400). They are fixed on the functional uprights using clip-nuts and M6 screws.

Selection of bars			
Bars		I(A)	
Cat.No	Cross-section (mm)	IP ≤ 30	IP > 30
0 374 18	25 x 5	330	270
0 373 18	32 x 5	450	400



Fix the busbar supports on the functional uprights of the cable sleeve using the clip-nuts and M6 screws provided. Insert the clip-nuts on the top profile of the uprights.

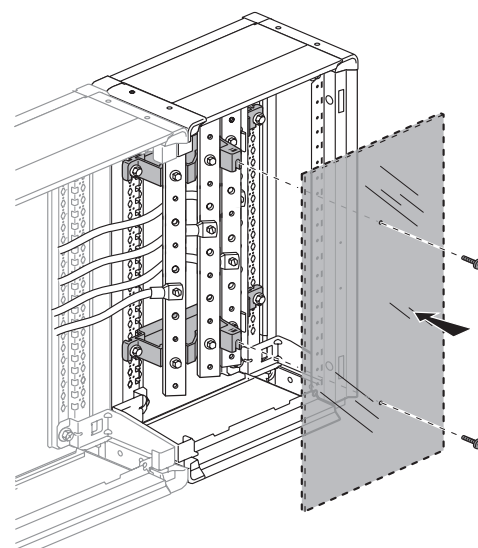

Position the copper bars on the supports.

Each busbar support is supplied with an isolating screw for fitting a protective screen if required.

Maximum distance (D) between supports according to the peak current (I_{pk})

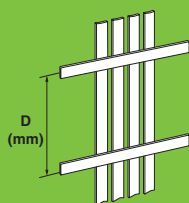

I _{pk} (kA)	Bars	
	374 34 (18 x 4)	374 18 (25 x 5)
10	800	900
15	700	800
20	550	700
25	400	500
30	350	400
35	300	350
40	300	300
45	200	200
50	175	100
55	150	100
60	150	



Fix the copper bars on the supports using M6 hex. head screws with integral washer.

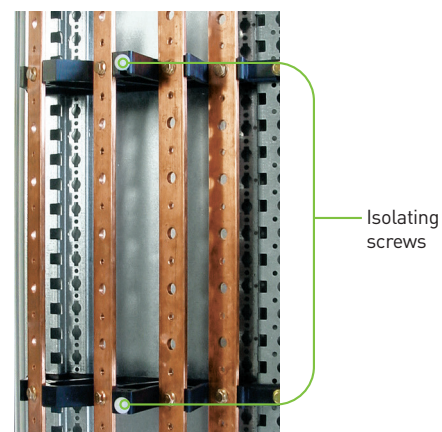

MOUNTING THE DISTRIBUTION SYSTEMS

2 MOUNTING A SLOPING BUSBAR

Isolating supports Cat.No 0 373 20 are used to create a sloping busbar up to 800 A in an external cable sleeve (XL³ 800).

Selection of bars			
Bars		I(A)	
Cat.No	Cross-section (mm)	IP ≤ 30	IP > 30
0 374 18	25 x 5	330	270
0 374 19	32 x 5	450	400
0 374 40	50 x 5	700	630
0 374 41	63 x 5	800	700

Maximum distance (D) between supports according to the peak current (I_{pk})

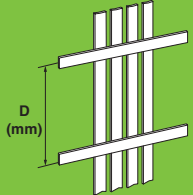

I _{pk} (kA)	Bars			
	374 18 (25 x 5)	374 19 (32 x 5)	374 40 (50 x 5)	374 41 (63 x 5)
10	800	900		
15	600	600	700	800
20	450	500	600	700
25	350	400	500	550
30	300	350	400	450
35	250	300	350	400
40	200	250	275	300
45	200	200	225	250
50	150	150	200	200
60	125	125	150	150
70	100	100	150	150
80				100

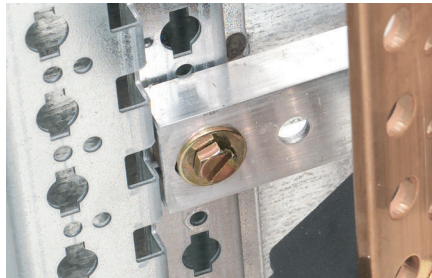

Fix the supports on the bottom profile of the functional uprights using clip-nuts and M6 screws (tightening torque 10 Nm)

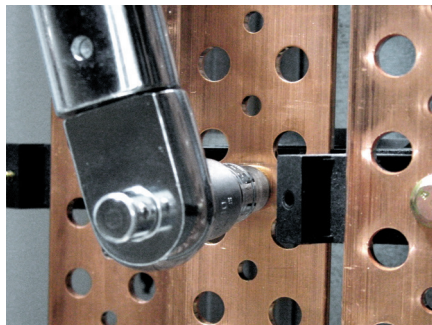

Fix the bars on the supports (tightening torque 7 Nm).

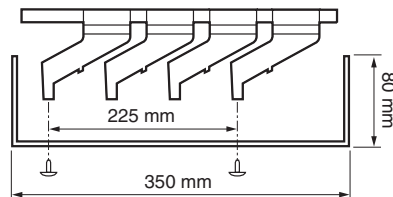

The supports are supplied with 2 screws for fitting a screen (not supplied)

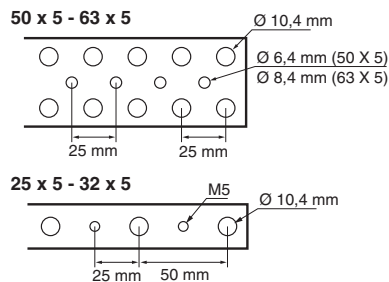

The copper bars have holes every 25 mm

3 MOUNTING THE 400 A DISTRIBUTION BLOCK CAT.NO 0 373 08 VERTICALLY

The 400 A distribution block can also be mounted vertically in an external cable sleeve (XL³ 400) or an internal cable sleeve (XL³ 800).

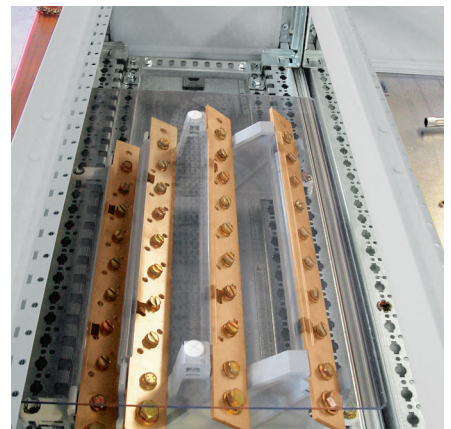

Fix the distribution block directly on the top profile of the functional uprights using 4 clip-nuts and 4 M6 screws

OTHER DISTRIBUTION DEVICES

Legrand standard distribution devices, which can be used in XL³ 400 and 800 enclosures, are suitable for a wide range of requirements, providing ease of use and safety.

MODULAR DISTRIBUTION BLOCKS

Legrand distribution blocks are totally isolated. They are used at the supply end of panels up to 250 A or in subgroups of outgoing lines in panels with higher power ratings. They are mounted on  rails.

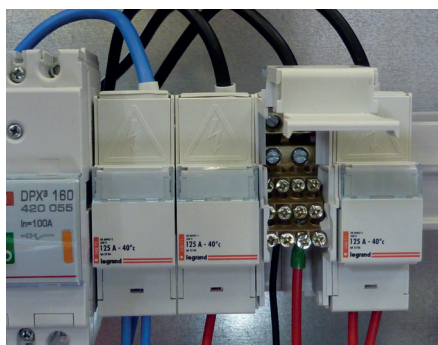

Single pole modular distribution block.



One-piece modular distribution blocks.

HX³ SUPPLY BUSBARS UP TO 63 A

One, two, three and four-pole supply busbars are connected directly and supply power to Lexic modular devices up to 100 A, depending on the type of power supply. They are a flexible, quick solution, take up little space and are easy to adapt for distribution in rows.

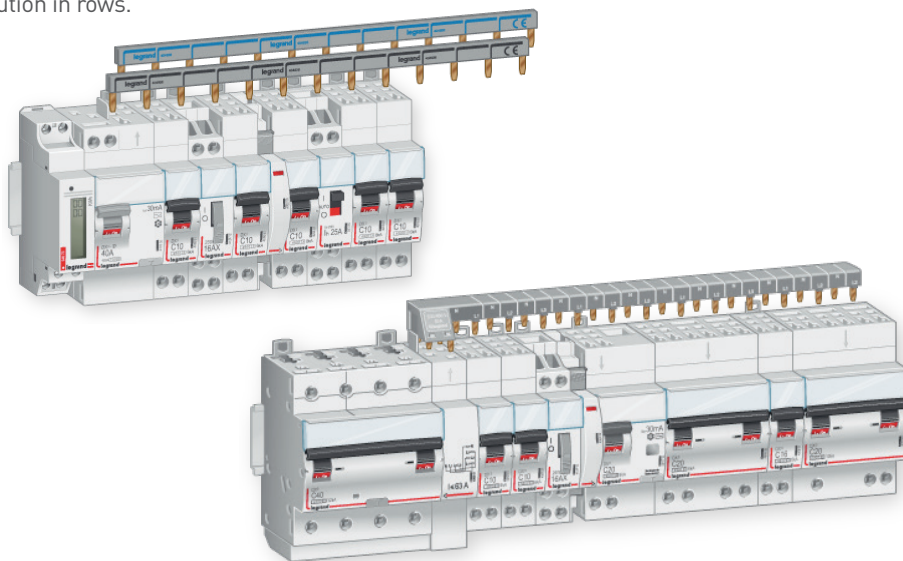

Examples of single-phase and 3-phase connections

DISTRIBUTION TERMINALS

These single pole distribution blocks are fixed directly on the terminals of DPX³ 160, DPX³ 250, 100 and 160 A Vistop, and DPX-IS 250 devices.



6 x 35 mm² rigid (25 mm² flexible) outgoing lines for the distribution terminal Cat.No 0 048 67.

ALUMINIUM/COPPER CONNECTION BOXES

These connection boxes provide the interface between large cross-section incoming conductors, including those made of aluminium, and internal wiring conductors.

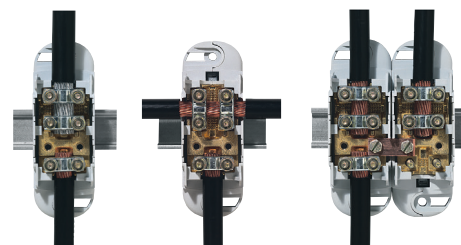

Examples of possible connections.

 Enables there to be large cross-section aluminium incoming lines then small cross-section copper outgoing lines inside the enclosure for ease of wiring.

MOUNTING THE DEVICES

PRINCIPLE FOR DEFINING THE REQUIRED SPACE

Each device, after fixing on a rail or plate, is fitted with a dedicated faceplate.

The height of this faceplate defines the space required for installing the devices, for their connection, for maintaining the necessary clearances and for optimum heat dissipation conditions.

Once the faceplates have been fitted, they provide IP 30 protection.

They are available in several heights:

- 150 mm to 600 mm for protection or breaking devices.

- 50 mm to 1800 mm for solid faceplates.

These provide the necessary areas for wiring, cable entries, installing busbars and fitting specific equipment.

Solid faceplates									
Height (mm)	XL ³ 400				XL ³ 800				
	Cabinets or enclosures		Cable sleeves		Cabinets or enclosures			Cable sleeves	
	Metal	Insulated	Metal	Insulated	24 modules		36 modules	Internal Screw	External Screw
					¼ turn	Screw	Screw		
50	0 203 40	0 203 90	0 201 41		0 208 40	0 209 40	0 209 90		
100	0 203 41	0 203 91	0 201 42		0 208 41	0 209 41	0 209 91		
150	0 203 42	0 203 92			0 208 42	0 209 42	0 209 92		
200	0 203 43	0 203 93	0 201 40		0 208 43	0 209 43	0 209 93		
300	0 203 44	0 203 94		0 201 97	0 208 44	0 209 44	0 209 94		
400				0 201 98	0 208 45	0 209 45	0 209 95		
550			0 201 43	0 201 99					
600					0 208 46	0 209 46	0 209 96		
700			0 201 44						
850			0 201 45						
1000			0 201 46						
1050								0 204 46	
1150			0 201 47						
1250								0 204 47	
1400								0 204 48	0 204 43
1450			0 201 48						
1750			0 201 49						
1800								0 204 49	0 204 44

SELECTION OF EQUIPMENT FOR MOUNTING DEVICES IN XL³ 400

DEVICE	TYPE OF ENCLOSURE	POSITION	CONFIGURATION	FIXING DEVICE	FACEPLATES			
					HEIGHT	METAL	INSULATED	
Modular In ≤ 63 A	Cabinet or enclosure	V		0 202 00 0 202 01	150	0 203 00	0 203 50	
	Cable sleeve	V		0 202 03	150	0 203 03	0 203 53	
Modular In > 63 A	Cabinet or enclosure	V		0 202 00 0 202 01	200	0 203 01	0 203 51	
	Cable sleeve	V		0 202 03	200	0 203 04		
Vistop In < 160 A	Cabinet or enclosure	V		0 202 00 0 202 01	200	0 203 01	0 203 51	
DPX ³ 160	Cabinet or enclosure	V	without side motor-driven handle	with e.l.c.b	0 202 11 + 4 210 73	300	0 203 10	0 203 60
				without e.l.c.b	0 202 11 + 4 210 71			
		V	with side motor-driven handle	0 202 11 + 4 210 68	300	0 203 10	0 203 60	
		V	direct rotary handle	0 202 09	300	0 203 09		
		V	manual supply inverter	0 202 11 + 4 210 58	300	0 203 10	0 203 60	
	H	with or without e.l.c.b	0 202 13	150	0 203 13	0 203 65		
Cable sleeve	V	with or without e.l.c.b	0 202 17	300	0 203 18			
DPX ³ 250	Cabinet or enclosure	V	without side motor-driven handle	with e.l.c.b	0 202 11 + 4 210 74	300	0 203 10	0 203 60
				without e.l.c.b	0 202 11 + 4 210 72			
		V	with side motor-driven handle	0 202 11 + 4 210 69	300	0 203 10	0 203 60	
		V	direct rotary handle	0 202 09	300	0 203 09		
		V	manual supply inverter	0 202 11 + 4 210 58	300	0 203 10	0 203 60	
	H	with or without e.l.c.b	0 202 15	200	0 203 17	0 203 66		
Cable sleeve	V	with or without e.l.c.b	0 202 17	300	0 203 18			
DPX-IS 250	Cabinet or enclosure	V	device only, centred	0 202 05	300	0 203 10	0 203 60	
	Cable sleeve	V	device only	0 202 17 + 0 262 39	300	0 203 18		
DPX 250	Cabinet or enclosure	V	several devices without e.l.c.b	0 202 20	400	0 203 20	0 203 70	
		V	device only, without e.l.c.b, centred	0 202 21	400	0 203 21	0 203 71	
		V	several devices, with e.l.c.b underneath	0 202 22	600	0 203 22	0 203 72	
		V	device only, with e.l.c.b underneath, centred	0 202 23	600	0 203 23	0 203 73	
		H	with or without e.l.c.b underneath	0 202 24	200	0 203 24	0 203 74	
	Cable sleeve	V	without e.l.c.b underneath	0 202 28	400	0 203 28		
		V	with e.l.c.b underneath	0 202 29	800	0 203 29		
DPX ³ 630	Cabinet or enclosure	V	without e.l.c.b	0 202 20	400	0 203 20	0 203 70	
		V	1 device without e.l.c.b, centred	0 202 21	400	0 203 21	0 203 71	
		V	device with e.l.c.b underneath	0 202 22	600	0 203 22	0 203 72	
		V	1 device with e.l.c.b underneath, centred	0 202 23	600	0 203 23	0 203 73	
		H	without e.l.c.b underneath	0 202 25	300	0 203 25		
	Cable sleeve	V	without e.l.c.b underneath	0 202 28	400	0 203 28		
		V	with e.l.c.b underneath	0 202 29	800	0 203 29		
DPX-IS 630	Cabinet or enclosure	V	device only	0 202 07	300	0 203 07		

MOUNTING THE DEVICES

SELECTION OF EQUIPMENT FOR MOUNTING DEVICES IN XL³ 800

DEVICE	TYPE OF ENCLOSURE	POSITION	CONFIGURATION		FIXING DEVICES	
					XL ³ 800 24 MODULES	XL ³ 800 36 MODULES
Modular < 63 A	Cabinet or enclosure	V			0 206 01	0 206 51
Modular > 63 A	Cabinet or enclosure	V			0 206 01	0 206 51
Vistop < 160 A	Cabinet or enclosure	V			0 206 01	0 206 51
DPX ³ 160	Cabinet or enclosure	V	without side motor-driven handle	with e.l.c.b	0 206 11 + 4 210 73	0 206 61 + 4 210 73
				without e.l.c.b	0 206 11 + 4 210 71	0 206 61 + 4 210 71
		V	with side motor-driven handle		0 206 11 + 4 210 68	0 206 61 + 4 210 68
		V	direct rotary handle		0 206 08 + 4 210 71	
		V	manual supply inverter		0 206 11 + 4 210 58	0 206 61 + 4 210 58
		V	motor-driven supply inverter		0 206 13 + 4 210 58	
		H	with or without e.l.c.b		0 206 15	
DPX ³ 250	Cabinet or enclosure	V	without side motor-driven handle	with e.l.c.b	0 206 11 + 4 210 74	0 206 61 + 4 210 74
				without e.l.c.b	0 206 11 + 4 210 72	0 206 61 + 4 210 72
		V	with side motor-driven handle		0 206 11 + 4 210 69	0 206 61 + 4 210 72
		V	direct rotary handle		0 206 08 + 4 210 72	
		V	manual supply inverter		0 206 11 + 4 210 58	0 206 61 + 4 210 58
		V	motor-driven supply inverter		0 206 13 + 4 210 58	
		H	with or without e.l.c.b		0 206 17	
DPX-IS 250	Cabinet or enclosure	V	device only, centred		0 206 05	
		V	1 or 2 devices		0 206 05	0 206 55
DPX 250	Cabinet or enclosure	V	several devices without e.l.c.b		0 206 20	0 206 70
		V	1 device without e.l.c.b, centred			
		V	several devices. with e.l.c.b underneath		0 206 22	0 206 72
		V	1 device without e.l.c.b, centred			
		V	supply inverter + motor		0 206 68	
		H	with or without e.l.c.b underneath		0 206 24	
		H	with or without e.l.c.b underneath + motor		0 206 21	
DPX ³ 630	Cabinet or enclosure	V	device without e.l.c.b		0 206 20	0 206 70
		V	1 device without e.l.c.b, centred			
		V	device with e.l.c.b underneath		0 206 22	0 206 72
		H	with or without e.l.c.b underneath		0 206 23	
DPX-IS 630	Cabinet or enclosure	V	device only		0 206 07	0 206 57
	Cable sleeve	V	device only		0 206 27	
DPX 1600	Cabinet or enclosure	V	device only		0 211 00	0 211 02
		H	device only		0 206 30	0 206 80
DPX-IS 1600	Cabinet or enclosure	V	device only		0 211 00	
		H	device only		0 206 30	

	FACEPLATES			
	HEIGHT	XL ³ 800 24 MODULES		XL ³ 800 36 MODULES
		1/4 TURN	SCREW	SCREW
	150	0 208 00	0 209 00	0 209 50
	200	0 208 01	0 209 01	0 209 51
	200	0 208 01	0 209 01	0 209 51
	300	0 208 10	0 209 10	0 209 60
	300	0 208 10	0 209 10	0 209 60
	300	0 208 05	0 209 05	
	300	0 208 10	0 209 10	0 209 60
	300	0 208 10	0 209 10	
	150	0 208 13	0 209 13	
	300	0 208 10	0 209 10	0 209 60
	300	0 208 10	0 209 10	0 209 60
	300	0 208 05	0 209 05	
	300	0 208 10	0 209 10	0 209 60
	300	0 208 10	0 209 10	
	200	0 208 17	0 209 17	
	300	0 208 10	0 209 10	
	300	0 208 06	0 209 06	0 209 60
	400	0 208 20	0 209 20	0 209 70
	400			
	600	0 208 22	0 209 22	0 209 72
	600			
	400	supplied in plate kit		
	200	0 208 24	0 209 24	
	200		0 209 24	
	400	0 208 20	0 209 20	0 209 70
	400			
	600	0 208 22	0 209 22	0 209 72
	300	0 208 23	0 209 21	
	300	0 208 07	0 209 07	0 209 57
	1550/1950		0 204 41/42	
	400	0 211 10	0 211 11	0 211 12
	400	0 208 34	0 209 34	0 209 84
	400		0 211 13	
	400		0 208 36	

MOUNTING THE DEVICES

1 POSITIONING THE FIXING DEVICES

Two clip-nuts must first be fitted on the functional uprights for mounting and locking the plates. It is essential to position these clip-nuts correctly, according to the faceplate layout. Likewise the rail fixing device attachment pieces must be positioned in accordance with this faceplate layout.



Two clip-nuts (provided) are sufficient to hold all versions of plates.

The positioning of a fixing device (plate or rail) depends on 3 criteria:

- The height of the faceplate: always a multiple of 50 mm
- The spacing of the fixing points on the functional uprights: 25 mm
- The reference point ("point 100"):

it is located 100 mm from the top of the faceplate frame and marked by the number 100, engraved on each functional upright

Principle: Divide the height of the faceplate by two. This gives the position for fitting the clip-nut or attachment piece in relation to a reference point.

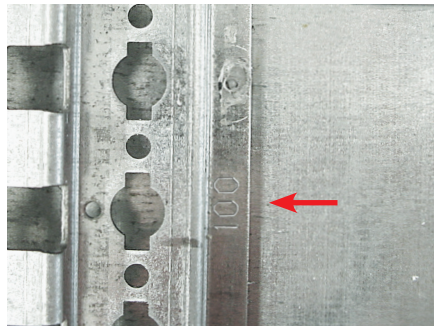

Point 100 is marked on the functional upright.

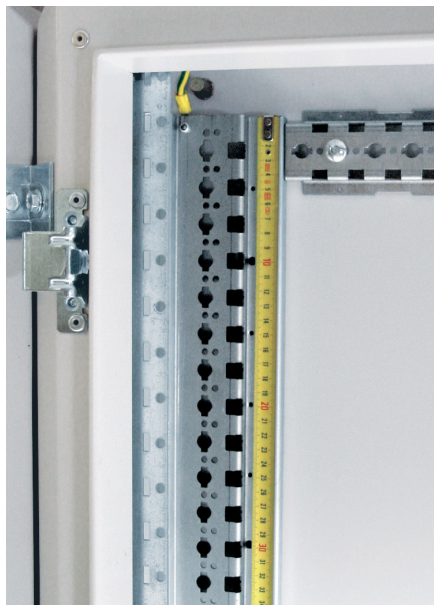

In IP 55 enclosures, point 0 corresponds to the top of the functional upright.

■ Positioning the clip-nuts for the plates

Example: mounting two plates and their faceplates at the top of the enclosure.

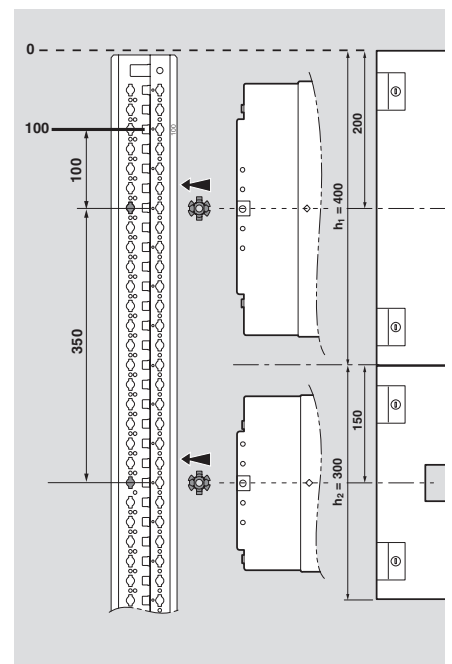

- 1st faceplate: height $h_1 = 400$ mm
Position of the plate fixing point in relation to the top of the faceplate frame: $400/2 = 200$ mm, i.e. 100 mm from point 100
- 2nd faceplate: height $h_2 = 300$ mm
Position of the plate fixing point in relation to the bottom of the 1st faceplate: $300/2 = 150$ mm, i.e. 350 mm from the 1st clip-nut ($150 + 200$)

2 MOUNTING DEVICES ON PLATES

■ Positioning the attachment pieces for rail fixing devices

Example: mounting two rail fixing devices and their faceplates at the supply end of the enclosure (see diagram below).

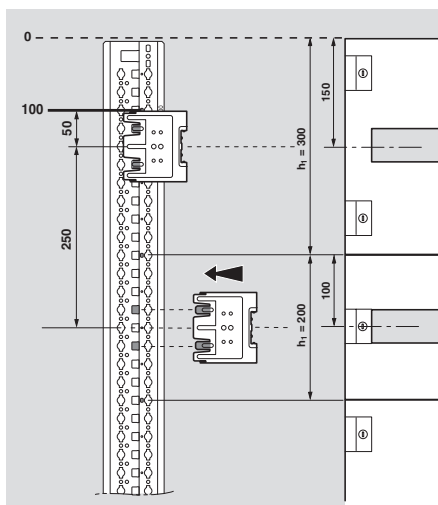

- 1st faceplate: height $h_1 = 300$ mm
Position of the attachment piece insertion point in relation to the top of the faceplate frame: $300/2 = 150$ mm, i.e. 50 mm from point 0
- 2nd faceplate: height $h_2 = 200$ mm
Position of the attachment piece insertion point in relation to the bottom of the 1st faceplate: $200/2 = 100$ mm, i.e. 250 mm ($100 + 150$) from the axis of the first attachment piece

After fitting the cage nuts [1], the next steps consist of fixing the devices on their plates [2] then attaching [3] and locking [4] the plates on the functional uprights previously fitted with clip-nuts.

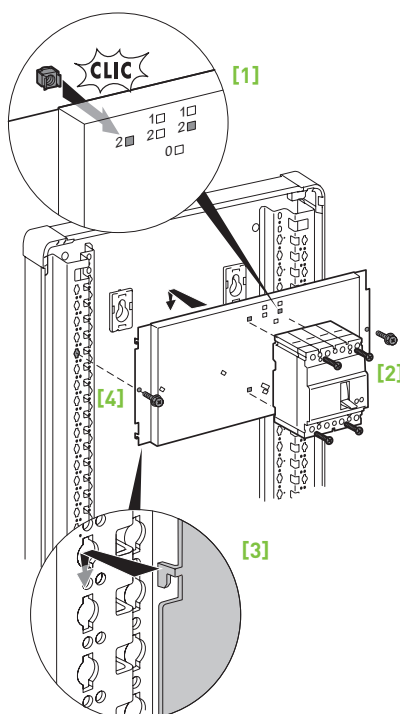

The XL PRO³ design software automatically calculates the positions of the plates and rails according to the layout of your panel.

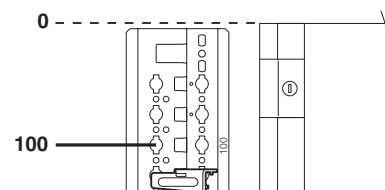
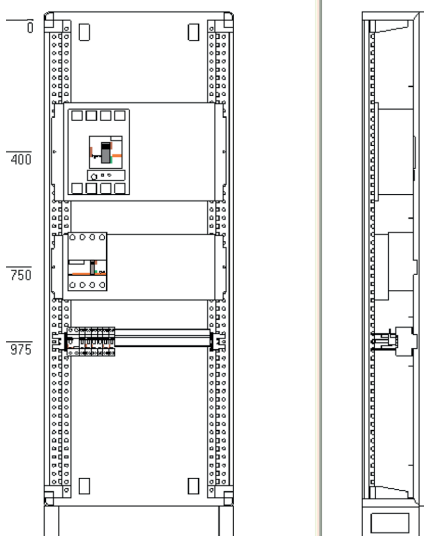

The positions indicated by XL PRO³ are given in relation to point 0 (located 6 mm above the end of the functional upright for XL³ 800 IP 30-40-43 enclosures).

MOUNTING THE DEVICES

FRENCH TARIFF CONNECTION PLATE

1 "BLUE TARIFF" KIT XL³ 400

The 3-phase French tariff connection kit Cat.No 0 202 31 is supplied equipped with a subscriber plate for circuit breaker, an electronic meter and a dedicated faceplate.

The single-phase French tariff connection kit Cat.No 0 202 30 is supplied without a subscriber plate. It can take one of the following plates:

- Cat.No 4 011 91 for incoming circuit breaker only This plate must be equipped with the insulated backplate Cat. No 4 011 93 for fixing on the metal plate and to ensure compliance with class II insulation.

- Cat.No 4 011 81 for incoming circuit breaker and Linky and CBE single phase electronic meter.

This kit is supplied with the dedicated faceplate and a 100 mm solid faceplate.



Fitting the cage nuts, via the rear of the metal plate.

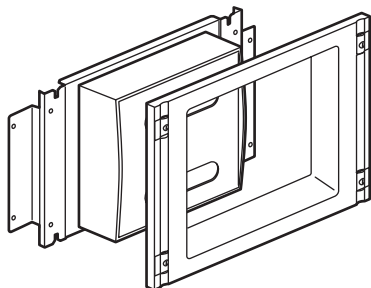

Cat.No 0 202 30

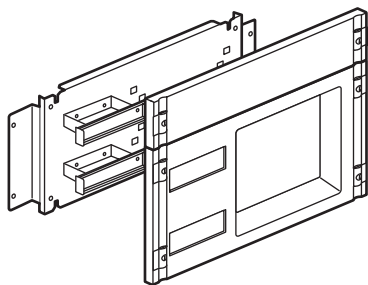

Cat.No 0 202 31

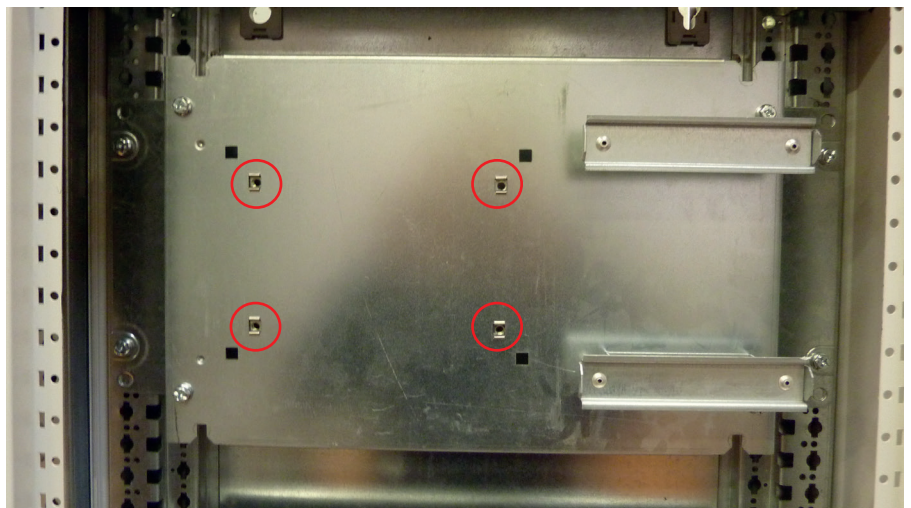

Fixing plates Cat.No 4 011 81 and 4 011 91 + 4 011 93.

2 "YELLOW TARIFF" KIT XL³ 400 AND XL³ 800

Legrand has two types of "yellow tariff" kits for mounting in cabinets, enclosures or cable sleeves:

- For circuit breaker only
- For isolating switch + circuit breaker

MAX. RATING	DEVICES	TYPE OF MOUNTING	FOR CABINET OR ENCLOSURE		FOR CABLE SLEEVE	
			XL ³ 400	XL ³ 800	XL ³ 400	XL ³ 800
250 A	DPX ³ 250	Horizontal	0 202 39	0 206 38		
		Vertical	0 202 50		0 202 47	
	DPX-IS 250 + DPX ³ 250	Vertical	0 202 27	0 206 35		
400 A	DPX 630	Vertical	0 202 36	0 206 36	0 202 37	0 206 37
		DPX-IS 630 + DPX 630	Vertical	0 202 33	0 206 33	

■ Mounting insulated plates

The insulated plates are supplied mounted on the device fixing plates for all kits except those which have two separate plates.

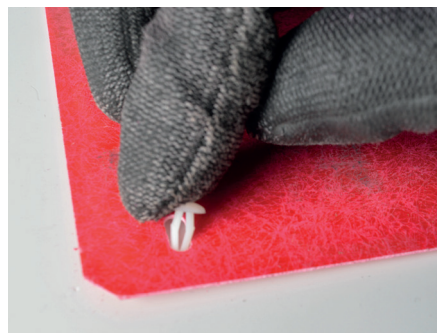
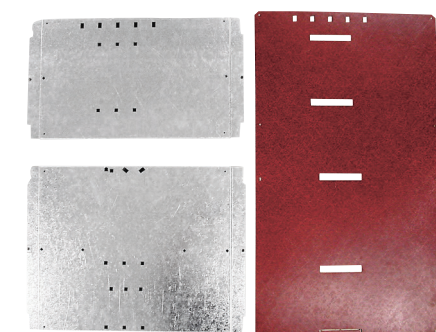

After fixing the 2 plates to the functional uprights in the enclosure, the insulated plate must be installed using the isolating clips provided.

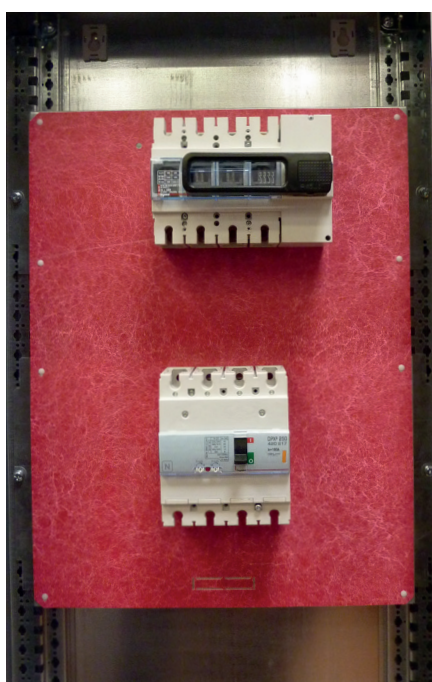

■ Holding the conductors in place

The conductors supplying the main device must be fixed on the device fixing plate using Colson cable ties.

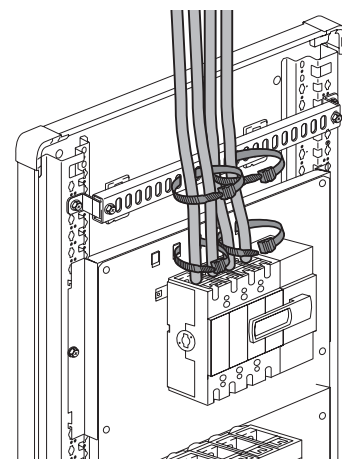
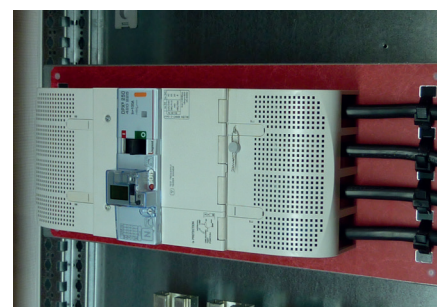

If the conductor cross-section is too large for fixing on the plate only, cable fixing supports can be used:

- XL³ 400: Cat.No 0 201 35 or 0 201 37
- XL³ 800: Cat.No 0 204 35, 0 204 36 or 0 204 37



Holding cables in position in a cable sleeve

WIRING THE PANELS

CABLE ENTRY

XL³ 400 and 800 metal cabinets and enclosures up to IP 43 are supplied with sheet metal side panels. To help make the cut-outs for the cable entries, an adjustable plastic plate is supplied with each enclosure.

This adjustable plate is also available separately:

XL³ 400: Cat.No 0 201 20

XL3 800: Cat.No 0 204 20

It is also possible to equip XL³ 400 cabinets and enclosures with pre-equipped cable entry plates.

These pre-equipped plates enable cables with an outer diameter of up to 16 mm to be inserted directly. The protection level after insertion of the cables is IP 43.

XL³ 400 metal cabinets: Cat.No 0 201 21

XL³ 400 insulated cabinets: Cat.No 0 201 71

For IP 55 enclosures, the cable entry plates are screwed directly onto the top of the enclosure. These plates can be fitted with cable glands, or they can be replaced by Cabstop plate Cat.No 0 364 97.



Break the top or bottom of the metal side panel along the pre-cut line

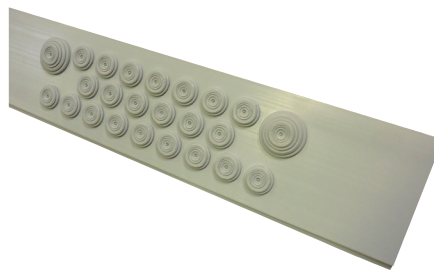

Pre-equipped cable entry plate Cat.No 0 201 71



Standard IP 55 cable entry plate



Cabstop plate Cat.No 0 364 97



Insert the plate between the back and the front of the side panel

WIRING

GUIDES FOR HORIZONTAL WIRING

The guides for horizontal wiring are quick to fit and do not require any tools. They simply clip on.

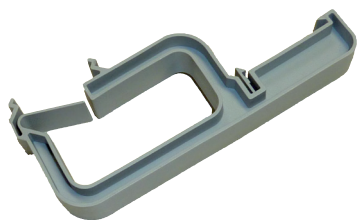

Wire guide Cat.No 4 052 25 for mounting on aluminium rail

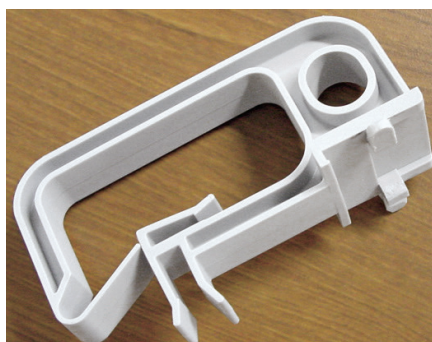

Wire guide Cat.No 0 200 94 - for mounting on universal rail

GUIDE FOR VERTICAL WIRING



The guide for vertical wiring Cat.No 0201 93 is fitted using clip-nuts and one M6 isolating screw. It is fixed to the top of the functional uprights.

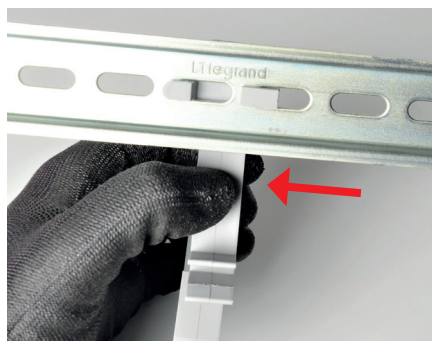

Example of wiring using guides

WIRING THE PANELS

LINA 25 DUCTING

■ Fixing on supports

The ducting fixing supports enable various heights of Lina 25 ducting to be mixed together vertically and horizontally in one enclosure, while optimising the connection of devices.

- XL³ 400: Cat.No 0 201 70
- XL³ 800 24 modules: Cat.No 0 204 70
- XL³ 800 36 modules: Cat.No 0 205 70

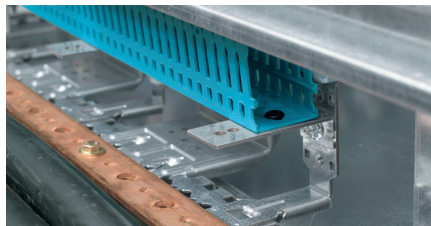

The ducting is fixed on the supports using the isolating rivets provided

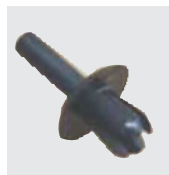

Additional isolating rivets, Cat.No 0 366 46, are available separately

■ Direct fixing on uprights



Rivets Cat.No 0 200 80 are used to fix Lina 25 ducting directly on the functional uprights



Rivet Cat.No 0 200 80

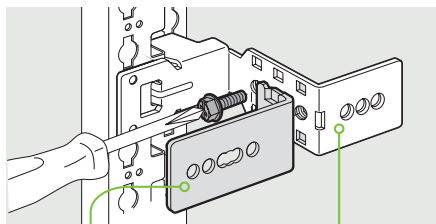

Side for vertical mounting

Side for horizontal mounting

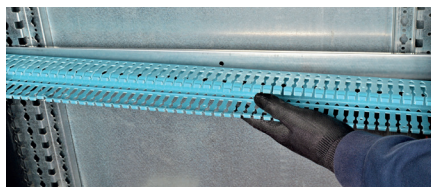

Supports Cat.No 0 205 70 are supplied with a profile to strengthen the horizontal ducting in 36-module enclosures.

CABLE TRAYS

Cablofil wire mesh can be installed vertically in XL³ 800 external cable sleeves. First install two fixing supports Cat.No 0 204 37 then fix the tray on these supports.

See Cablofil catalogue for the catalogue numbers of the trays.



ENCLOSURE	HEIGHT OF DUCTING THAT CAN BE MOUNTED	
	VERTICALLY	HORIZONTALLY
XL ³ 400	60 or 80 mm	60 mm
XL ³ 800	60, 80 or 100 mm	60 mm

PROTECTIVE CONDUCTORS

The main terminal of the protective conductors is used to connect:

- The main protective conductor
- The protective conductors of the load circuits
- Optionally, the protective conductor of the transformer
- The equipotential links

This type of connection can be made in XL³ enclosures using the following solutions:

- Terminal blocks (unprotected or IP 2x) mounted on 12 x 2 mm flat bar
- Ready to use bar with holes Cat.No 0 373 01
- Flat copper bar with clamps Cat.No 0 373 02
- 12 x 4 mm non-perforated copper bar Cat.No 0 373 49
- Copper bar with tapped holes Cat.No 373 89
- Viking terminal blocks mounted on rail

TERMINAL BLOCKS (UNPROTECTED OR IP 2X)

These terminal blocks must be mounted on the 12 x 2 flat bar which is sold by the metre (Cat.No 0 048 19).

Cutting and drilling the flat bar

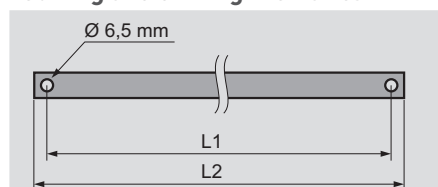

ENCLOSURE	L1	L2
XL ³ 400	440 mm	455 mm
XL ³ 800	525 mm	540 mm

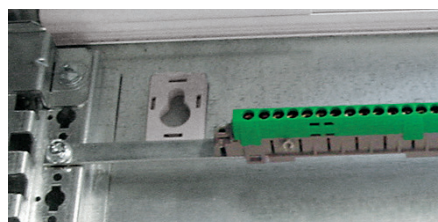

Mounting the flat bar directly on the functional uprights

COPPER BAR WITH TAPPED HOLES CAT.NO 0 373 89

This bar, cross-section 12 x 4 mm, can be mounted at the back of the enclosure, on the functional uprights, or on isolating support Cat.No 0 200 90 to create insulated earths.

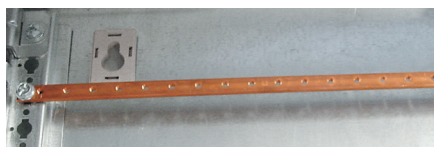

Connectors specially designed for the copper bar with tapped holes Cat.No 0 373 65 are used to connect 1.5 to 10 mm cross-section conductors

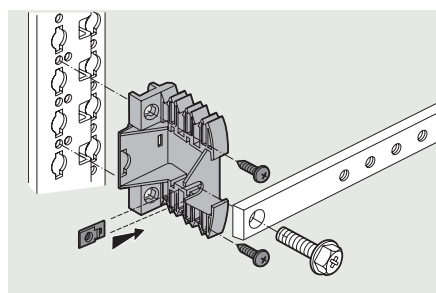
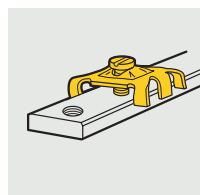

Mounting on isolating supports Cat.No 0 200 90 (class II)

READY TO USE BAR WITH HOLES CAT.NO 0 373 01



This bar has 36 x Ø 5.3 mm holes for (wire cross-sections from 1.5 to 10 mm²) and 2 x Ø 9 mm holes (for wire cross-sections up to 35 mm²).

It can be installed on the functional uprights of XL³ 400 enclosures using the fixing brackets provided, on wire guides Cat.No 0 200 94 or on support end stops Cat.No 0 375 12.



Mounting on support end stop Cat.No 0 375 12

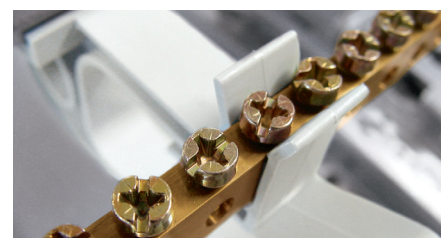

Mounting on guide Cat.No 0 200 94

WIRING THE PANELS

FLAT COPPER BARS WITH CLAMPS CAT.NO 0 373 02

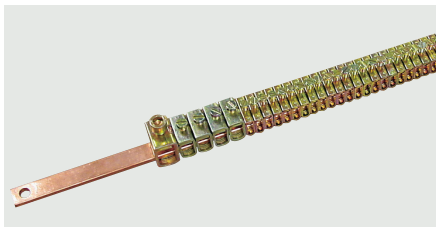

The 12 x 4 mm cross-section flat bar is supplied with:

- 40 clamp connectors for 1.5 to 4 mm² conductors
- 4 clamp connectors for 6 to 16 mm² conductors
- 1 clamp connector for conductors with cross-sections up to 35 mm²

The non-perforated copper bar sold by the metre Cat.No 0 373 49 and the following clamp connectors can be used to create a "made to measure" terminal block:

- Cat.No 0 373 60 for 1.5 mm² conductors
- Cat.No 0 373 61 for 6 to 16 mm² conductors
- Cat.No 0 373 62 for 10 to 35 mm² wires

These bars can be fixed directly to the XL³ 400 functional uprights or on isolating supports Cat.No 0 200 90 to create insulated earths.

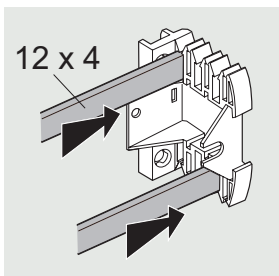

Mounting on isolating support Cat. No 0 200 90

VIKING TERMINAL BLOCKS MOUNTED ON L RAIL

Capacity: 0.25 mm² to 50 mm² for rigid conductors (up to 35 mm² for flexible conductors). These are used for connecting and interconnecting protective conductors.

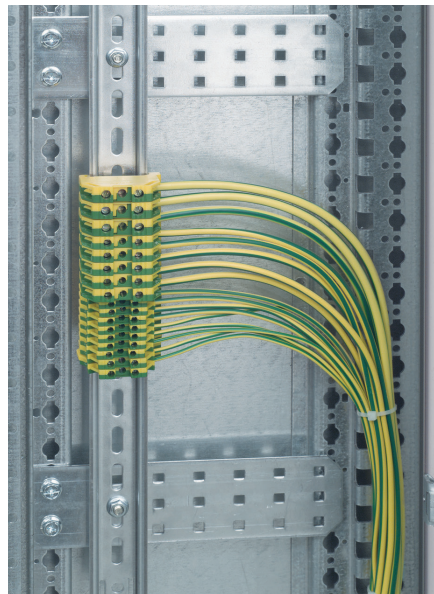

Viking terminal blocks on rail with universal support Cat.No 0 201 95 (for external cable sleeves)

DEDICATED COPPER BAR

The copper bar, which is most commonly installed in the cable sleeve, is required as soon as the cross-section of the conductors is 16 mm² or more.



Main terminal in cable sleeve consisting of a 32 x 5 mm copper bar

DETERMINING THE CROSS-SECTION OF THE PROTECTIVE CONDUCTOR

Phase conductor cross-section (S in mm ²)	Minimum cross-section of the protective conductor (S _{PE} in mm ²)
S ≤ 16	S
16 < S ≤ 35	16
S > 35	S/2

OUTPUT TERMINAL BLOCKS

Viking terminal blocks combined with Legrand rails can be used to create output terminal blocks and terminal blocks for protective conductors.

STANDARD HORIZONTAL TERMINAL BLOCK

Rails Cat.No 206 02 (24 modules) and Cat.No 206 52 (36 modules) are used to create connector blocks in XL3 800 cabinets and enclosures.

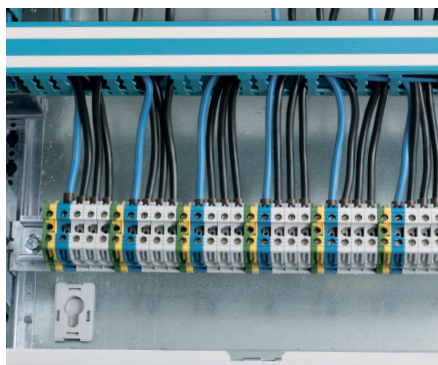

Output terminal block at the bottom of the enclosure on rail Cat.No 206 02



The depth of rails Cat.No 0 206 02/52 can be adjusted and they can be sloped at angles of up to 45°.

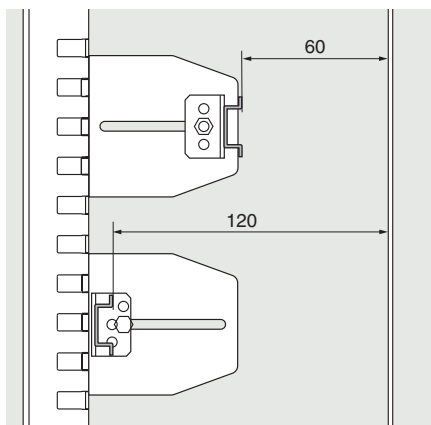

Minimum and maximum distances between rail Cat.No 0 206 02/52 and faceplate

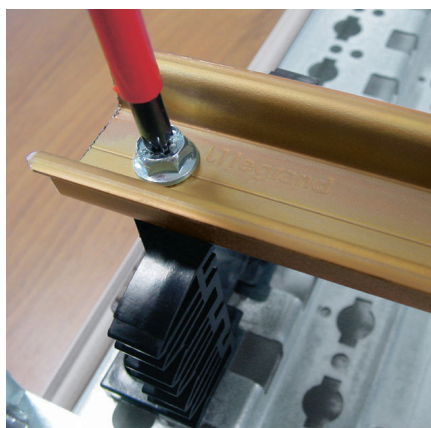

Another solution is to fix a rail on isolating supports Cat.No 0 200 90

VERTICAL TERMINAL BLOCK IN CABLE SLEEVE

It is possible to create a vertical terminal block using supports Cat.No 0 201 95 for external cable sleeves or Cat.No 0 201 96 for internal cable sleeves, and rails Cat.No 0 374 04/07 cut to the required length.

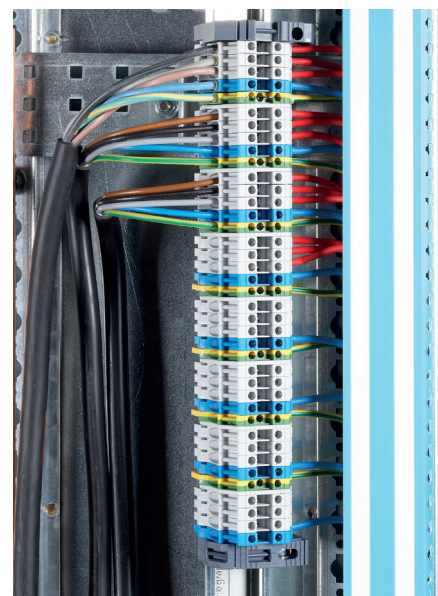

Example of creating a vertical terminal block using the universal support for internal cable sleeves Cat.No 0 201 96



Supports Cat.No 0 201 95/96 can be used to create a flat or sloping terminal block. They can also be used for fixing cables or up to two earth bars

INSTALLING THE ENCLOSURES

TRANSPORT AND HANDLING



Assembled enclosures should preferably be transported flat and should not be stacked.

Enclosures can also be transported in a vertical position, back to back on pallets, taking all necessary precautions to hold and strap them in position.

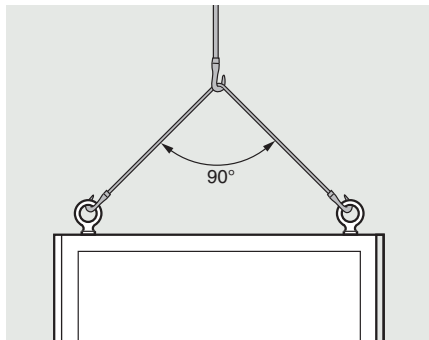

It is advisable to limit the angle between the slings to 90°



Protect assembled and equipped enclosures with the re-usable packaging.

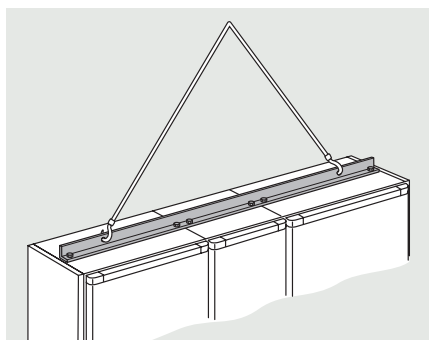

It is advisable to use a bolted bracket in place of the rings when using a sling to hoist an assembly consisting of several enclosures

LIFTING USING A SLING (IP 55 ENCLOSURES)

Lifting rings Cat.No 0 204 82 can be fitted for easy handling of **IP 55** enclosures. The rings must be turned round according to the direction of the slings: lateral forces on incorrectly positioned rings can lead to their breaking.

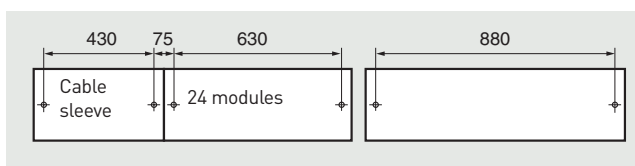

Spacing of the fixing points of the lifting rings (in mm)

FIXING THE ENCLOSURES

XL³ 400 and 800 cabinets and enclosures must be fixed to a wall or a partition. This can be done via the internal fixing points or using external fixing lugs.

INTERNAL FIXINGS

Knock out the blanking plates then fix the enclosure using \varnothing 6 mm screws and washers.

The internal fixings are always accessible, even when equipment is installed in the enclosure.

Do not forget to replace the isolating screw cover for class II enclosures.



The keyhole shaped openings enable the cabinets to be attached and removed easily

EXTERNAL FIXINGS

Enclosures can be fixed using lugs:

- Cat.No 0 201 00 for metal enclosures
- Cat.No 0 201 50 for insulated cabinets



Remove the plastic cover at the rear of the enclosure and fit the clip-nut

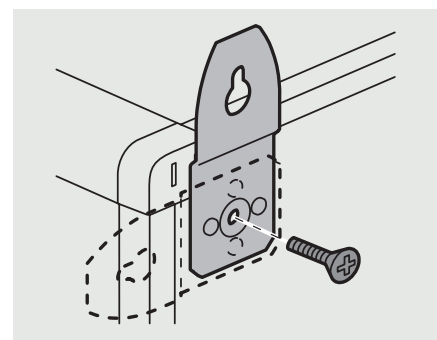

Then screw on the lug in the required position

INTERNAL AND EXTERNAL FIXING CENTRES (mm)

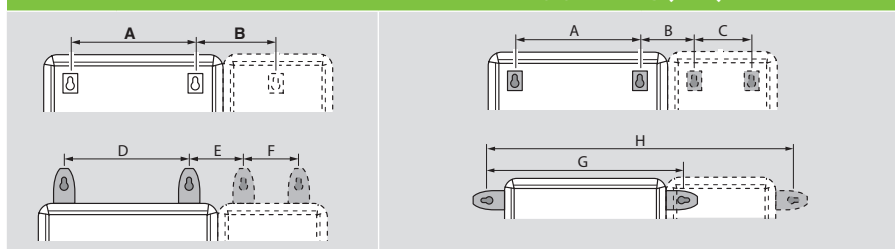

	XL ³ 400	XL ³ 800	
		24 modules	36 modules
A	330	415	665
B	277.5	245	245
C	-	215	215
D	475	560	810
E	100	100	100
F	210	360	360
G	625	710	960
H	935	1170	1420

INSTALLING THE ENCLOSURES

IP 55 ENCLOSURES

To ensure IP 55 protection, the cabinets and enclosures are fixed using the external fixing lugs supplied with the enclosure (4 lugs for cabinets, 2 for enclosures). They are mounted on the back of the enclosure.

FIXING CENTRES (mm)				
XL ³ 400		H	A	B
		515		575
		715	540	775
		915		975
	1115		1175	
XL ³ 800	24 modules	1095	540	1165
		1295		1365
	36 modules	1095	874	1165
		1295		1365
	Ext. cable sl.	1095		1165
		1295	424	1365

FIXING TO THE FLOOR

The plinths have four Ø 11 mm holes drilled in them for fixing the enclosures to the floor.

FIXING CENTRES (mm)			
		A	B
XL ³ 400	Enclosure	505	105
	Ext. cable sl.	238	
XL ³ 800	Enclosure 24 modules	630	155
	Enclosure 36 modules	884	
	Ext. cable sl.	432	

DIMENSIONS

XL³ 400 METAL AND INSULATED

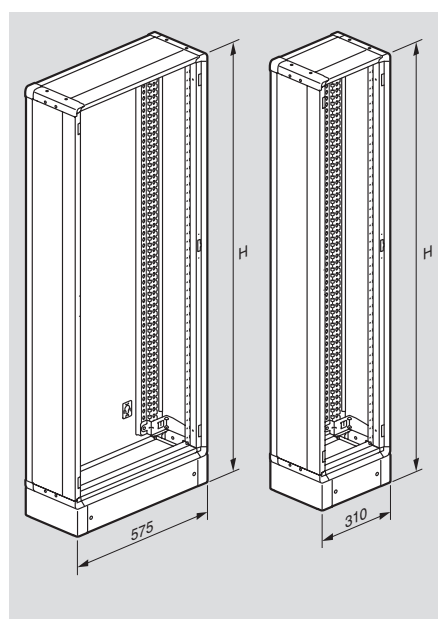

Enclosures	Cable sleeves	H (mm)
0 201 18	0 201 38	1600
0 201 19	0 201 39	1900

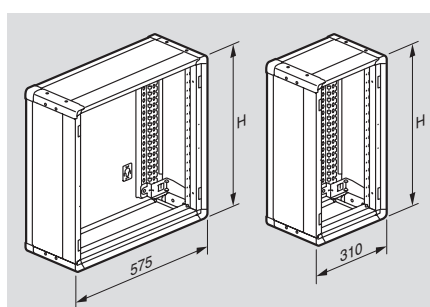

Cabinets	Cable sleeves	H (mm)
0 0 201 03/53	0 201 23/73	600
0 201 04/54	0 201 24/74	750
0 201 05/55	0 201 25/75	900
0 201 06/56	0 201 26/76	1050
0 201 07/57	0 201 27/77	1200
0 201 08	0 201 28	1500

XL³ 400 IP 55

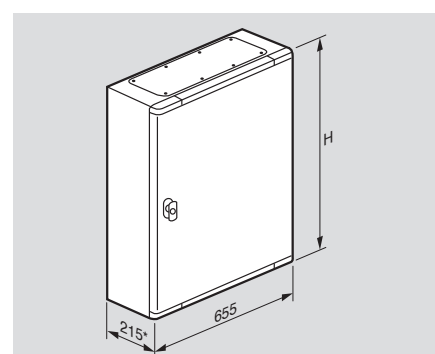

* excluding the handle

IP 55 cabinets	H (mm)
0 201 82	515
0 201 83	715
0 201 84	915
0 201 85	1115

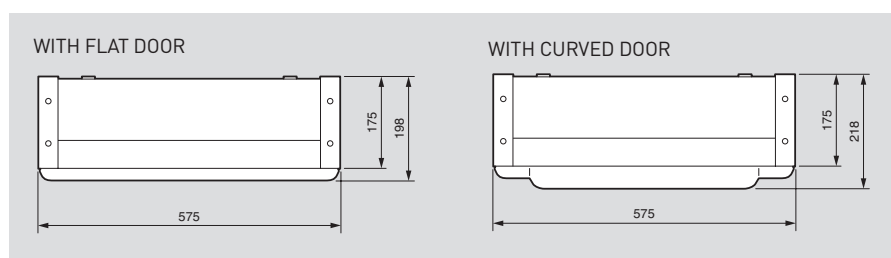

XL³ 800

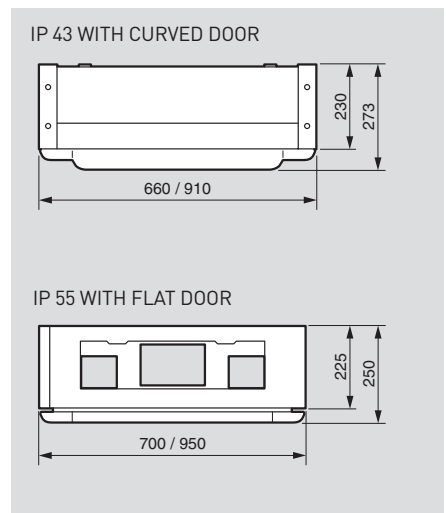
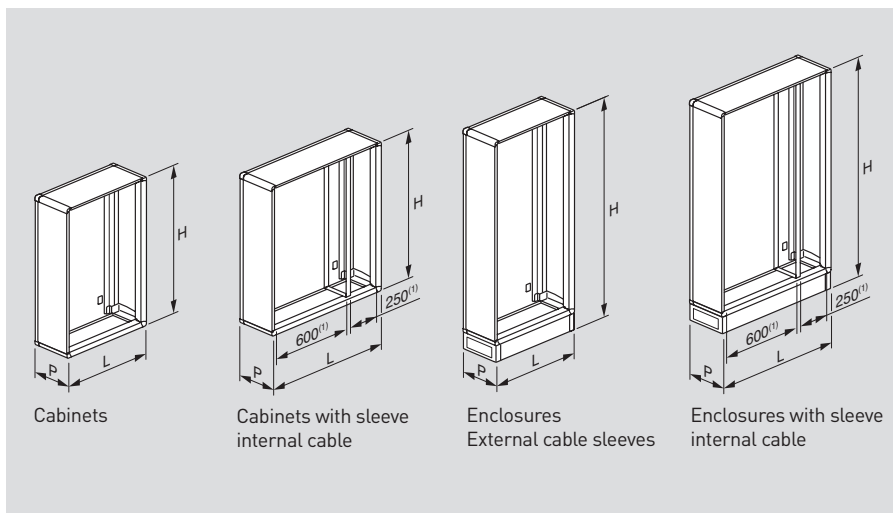

IP 30-40-43 enclosures		W (mm)	H (mm)	D (mm)
Cabinets with internal cable sleeve	0 204 01	660	1050	230
	0 204 02	660	1250	230
	0 204 06	910	1050	230
	0 204 07	910	1250	230
Enclosures	0 204 03	660	1550	230
	0 204 04	660	1950	230
	0 204 08	910	1550	230
	0 204 09	910	1950	230
Enclosures with internal cable sleeve	0 204 23	460	1550	230
	0 204 24	460	1950	230
IP 55 enclosures		W (mm)	H (mm)	D (mm)
Cabinets	0 204 51	700	1095	225
	0 204 52	700	1295	225
	0 204 56	950	1095	225
	0 204 57	950	1295	225
Enclosures	0 204 53	700	1595	225
	0 204 54	700	1995	225
	0 204 58	950	1595	225
	0 204 59	950	1995	225
Cable sleeves	0 204 73	500	1595	225
	0 204 74	500	1995	225

ACCESSORIES

ACCESSORIES FOR XL ³ 400 CABINETS AND ENCLOSURES		METAL	INSULATED	IP 55
	External fixing lugs	0 201 00	0 201 50	-
	Plinths for cabinets and enclosures	0 201 10	0 201 10	-
	Plinths for cable sleeves	0 201 12	0 201 12	-
	IP 43 kit	0 201 30	0 201 30	-
	Universal plate for cabinets and enclosures H: 200 mm	0 202 41	0 202 41	0 202 41
	Universal plate for cabinets and enclosures H: 300 mm	0 202 42	0 202 42	0 202 42
	Universal plate for cable sleeve H: 300 mm	0 202 43	0 202 43	-
	Universal rail W: 515 mm	0 202 04	0 202 04	0 202 04
	Horizontal partitioning divider	0 201 90	0 201 90	0 201 90
	Adjustable cable entry plate	0 201 20	-	-
	Knockout cable entry plate	0 201 21	0 201 71	-
	Cabstop cable entry plate	-	-	0 364 97
	Isolating supports	0 200 90	0 200 90	0 200 90
	M6 clip-nuts (20)	0 200 92	0 200 92	0 200 92
	M6 screws (50)	0 200 91	0 200 91	0 200 91
	Lina 25 ducting fixing support	0 201 70		
	Isolating rivet for fixing ducting on functional uprights	0 200 80		
	Cable fixing for cabinets and enclosures	0 201 35		
	Cable fixing for cable sleeve (except for IP 55)	0 201 37	-	
	DLP finishing strip	0 201 60		
	Lighting kit width 515 mm	0 203 89	-	-
	Linkage system	9 802 84	-	-
	Selftapping screw M6x10 (x100)	9 802 91	-	-
	4 corner kit	9 802 94	-	-
	Handle with card for XL ³ 400 cabinet	-	-	9 802 88

ACCESSORIES FOR XL ³ 800 CABINETS AND ENCLOSURES		IP 30-43			IP 55		
		24 MOD.	36 MOD.	C. SLEEVE	24 MOD.	36 MOD.	C. SLEEVE
	External fixing lugs	0 201 00	0 201 00	0 201 00	supplied with the enclosure		
	Plinth	0 204 10	0 204 11	0 204 12	0 204 60	0 204 61	0 204 62
	IP 43 kit	0 201 30			-	-	-
	Joining kit	-	-	-	0 204 86		
	Sealing kit for joining	-	-	-	0 205 85		
	Universal rail	0 206 04	0 206 54	-	0 206 04	0 206 54	-
	Adjustable universal rail	0 206 02	0 206 52	-	0 206 02	0 206 52	-
	Adjustable cable entry plate	0 204 20			-	-	-
	Cabstop cable entry plate	-	-	-	0 364 97 + 0 364 98	0 364 96 [x2] + 0 364 98 [x 2]	0 364 96 + 0 364 98
	Perforated plate H: 200 mm	0 206 41	-	-	0 206 41	-	-
	Perforated plate H: 400 mm	0 206 42	-	-	0 206 42	-	-
	Solid plate H: 200 mm	0 206 43	-	-	0 206 43	-	-
	Solid plate H: 400 mm	0 206 44	0 202 46	-	0 206 44	0 202 46	-
	Solid plate H: 600 mm	0 206 45	-	-	0 206 45	-	-
	Horizontal partitioning divider	0 204 90	0 204 91	-	0 204 90	0 204 91	-
	Lifting rings (set of 2)	-	-	-	0 204 82		
	Cable fixing for cabinets and enclosures	0 204 35	0 204 36	0 204 37	0 204 35	0 204 36	0 204 37
	Lina 25 ducting fixing support	0 205 70	0 204 70	-	0 205 70	0 204 70	-
	Isolating rivet for fixing Lina 25 ducting on functional uprights	0 200 80					
	Hinges for faceplates	0 209 59					
	Lighting kit XL ³ 800 for mounting on supplied plate	-	0 209 89	-	-		
	Linkage system XL ³ 800 door L 1800 mm	9 802 85					
	Handle with card XL ³ cabinets	-			9 802 88		
	Faceplate fixing kit (x4)	9 802 92					

XL ³ 400/800 COMMON ACCESSORIES		
	Key barrel type 405	0 202 91
	Key barrel type 455	0 202 92
	Key barrel type 1242E	0 202 93
	Key barrel type 2433A	0 202 94
	Double bar metal rebate lock	0 202 96
	Equipotential link conductor	0 373 85
	Self-adhesive plastic document holder, flexible Dimensions: 305 x 220 mm	0 097 99
	Self-adhesive plastic document holder, rigid, closed Internal dimensions: 324 x 120 x 18 mm	0 365 82
	Self-adhesive document holder, rigid, open Internal dimensions: 230 x 130 x 18 mm	0 365 81
	Replacement handle for enclosure H ≥ 1500	0 202 99
	24-module smooth adjustable blanking plate	0 200 51
	18-module separable blanking plate	0 016 65
	Adhesive label holder	0 203 99
	Horizontal wire guides	0 200 94/4 052 25
	Vertical wire guides	0 201 93
	M6 clip-nuts (x20)	0 200 92
	M6 screws (x50)	0 200 91
	Aerosol paint spray RAL 7035 - 400 ml	0 200 98
	Linkage system XL ³ 800 door L 1450 mm	9 802 83
	Linkage system XL ³ 800 door L 1000 mm	9 803 83
	Kit door for XL ³ 800 cabinet	9 802 86
	Handle for XL ³ 800 cabinet	9 802 87
	Lock system linkage for XL ³ 800 cabinet (x10)	9 802 93

To know more,
check [export.legrand.com](https://www.export.legrand.com)



All technical data of the products inside this workshop specifications book are available on : <https://www.export.legrand.com/en>

>Click on >DOCUMENTATION & SOFTWARE

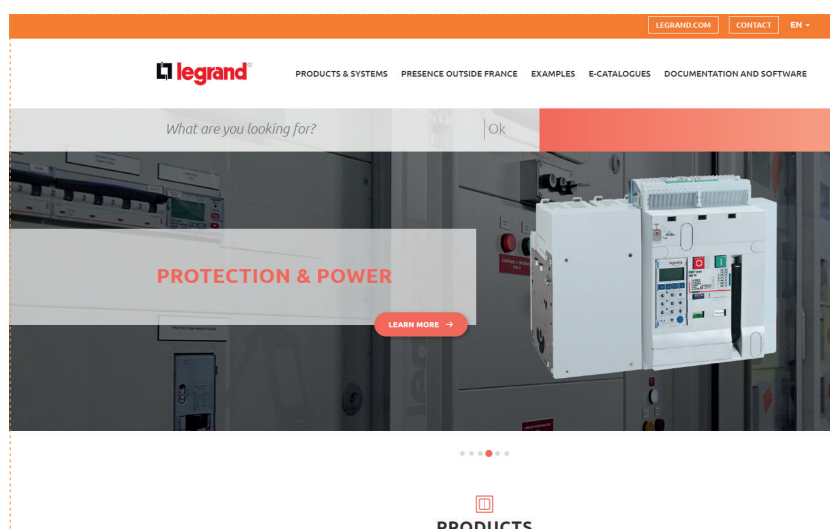

>Documentation

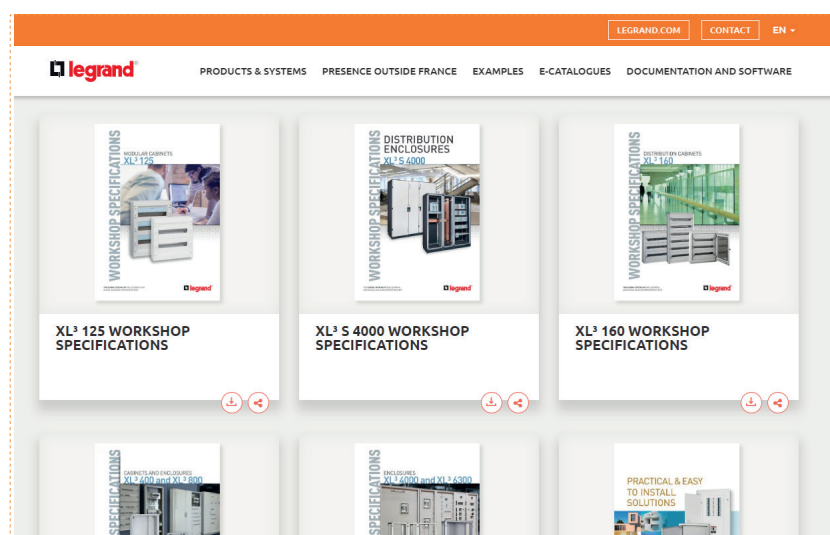



FOLLOW US
ALSO ON

- @ legrand.com
-  youtube.com/user/legrand
-  facebook.com/Legrand
-  twitter.com/Legrand
-  pinterest.com/legrandgroup
-  instagram.com/legrandnews



Head office
and International Department
87045 Limoges Cedex - France
Tel: + 33 (0) 5 55 06 87 87
Fax: + 33 (0) 5 55 06 74 55