

Driver LCU 100/96W 12/24V IP20 EXC
excite series

Product description

- Constant voltage LED Driver
- Universal input voltage range
- Constant output voltage
- Push terminals for simple wiring
- Nominal life-time up to 50,000 h (at ta 45 °C with a failure rate max. 0.2 % per 1,000 h)
- 5-year guarantee
- Complies with CLASS C from minimum to maximum load range according to EN 61000-3-2



Properties

- Small design
- High efficiency
- Low power loss
- Overtemperature and overload protection
- Short-circuit shutdown feature with automatic restart
- Protection class II, SELV
- Type of protection IP20
- Plastic casing white



IP20 SELV          

Driver LCU 100/96W 12/24V IP20 EXC excite series

Technical data

Rated supply voltage	120 – 277 V
AC voltage range	108 – 305 V
Rated current 12 V (at 230 V 50 Hz)	0.51 A
Rated current 24 V (at 230 V 50 Hz)	0.49 A
Mains frequency	50 / 60 Hz
Efficiency	> 90 %
λ (at 230 V 50 Hz)	0.95
Max. input power in no-load operation	0.5 W
Output voltage tolerance 12 V	-0 / +10 %
Output voltage tolerance 24 V	-0 / +5 %
Output power 12 V ($t_a \leq 60$ °C)	100 W
Output power 12 V ($t_a > 60$ °C)	70 W
Output power 24 V ($t_a \leq 50$ °C)	96 W
Output power 24 V ($t_a > 50$ °C)	67 W
Output power range 12 V	10 – 100 W
Output power range 24 V	10 – 96 W
Starting time (output)	≤ 0.5 s
Turn off time (output)	≤ 1 s
Hold on time at power failure (Output)	10 ms
Mains surge capability (between L - N)	1 kV
Mains surge capability (between L/N - PE)	1 kV
Surge voltage at output side (against PE)	< 500 V
Ambient temperature t_a (12 V)	-25 ... +70 °C
Ambient temperature t_a (24 V)	-25 ... +60 °C
Ambient temperature t_a (at life-time 50,000 h)	-25 ... +45 °C
Storage temperature	-40 ... +85 °C
Life-time	up to 50,000 h
Dimensions LxWxH for 12 V	300 x 44 x 23 mm
Dimensions LxWxH for 24 V	300 x 40 x 21 mm
Hole spacing D	273 mm

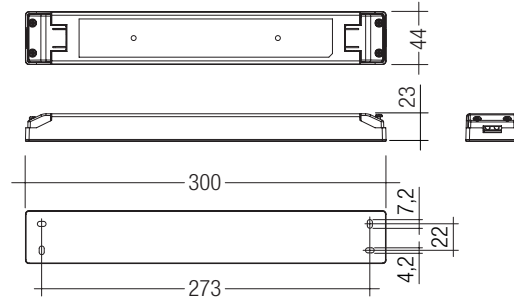

LCU 100W 12V SR top

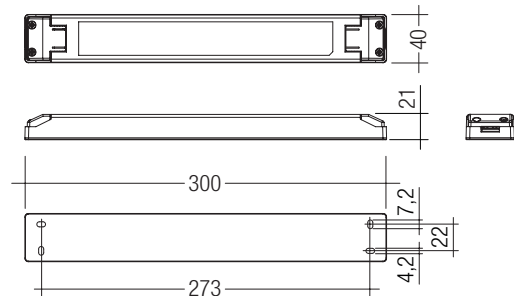

LCU 96W 24V SR top

Ordering data

Type	Article number	Packaging carton	Packaging pallet	Weight per pc.
LCU 100W 12V SR top	28000408	20 pc(s).	1,000 pc(s).	0.46 kg
LCU 96W 24V SR top	28000413	20 pc(s).	1,000 pc(s).	0.34 kg

Specific technical data

Type	Max. casing temperature t_c	Output voltage	Max. input power	Output current range
LCU 100W 12V SR top	85 °C	12 V	117 W	830 – 8,330 mA
LCU 96W 24V SR top	85 °C	24 V	117 W	400 – 4,000 mA

Standards

- EN 55015
- EN 60598-1
- EN 60598-2-22
- EN 61000-3-2
- EN 61000-3-3
- EN 61347-1
- EN 61347-2-13
- EN 61547
- EN 62384
- EN 62493

Overload protection

Automatic shutdown of the LED Driver if the maximum output current is exceeded. Automatic restart if the output current is below the limit.

No-load operation

The LED Driver is not damaged in the no-load operation. The max. output voltage (see page1) can be obtained during no-load operation.

Over temperature protection

Automatic shutdown of the LED Driver if the temperature limit is exceeded. Automatic restart if the temperature falls below the limit.

Short-circuit behaviour

In case of a short circuit on the secondary side (LED) the LED Driver switches into hiccup mode. After removal of the short-circuit fault the LED Driver will recover automatically.

Glow wire test

according to EN 61347-1 with increased temperature of 850 °C passed.

Expected life-time

Type	Output voltage	ta	35 °C	45 °C	55 °C
LCU 100W 12V SR top	12 V	tc	69 °C	79 °C	89 °C
		Life-time	> 100,000 h	> 50,000 h	> 25,000 h
LCU 96W 24V SR top	24 V	tc	65 °C	75 °C	85 °C
		Life-time	> 100,000 h	> 50,000 h	> 25,000 h

Maximum loading of automatic circuit breakers in relation to inrush current

Automatic circuit breaker type	C10	C13	C16	C20	B10	B13	B16	B20	Inrush current
Installation Ø	1.5 mm ²	1.5 mm ²	1.5 mm ²	2.5 mm ²	1.5 mm ²	1.5 mm ²	1.5 mm ²	2.5 mm ²	I _{max} time
LCU 100W 12V SR top	10	13	16	20	6	8	10	12	614 A 83 µs
LCU 96W 24V SR top	10	13	16	20	6	8	10	12	674 A 66 µs

This are max. values calculated out of inrush current! Please consider not to exceed the maximum rated continuous current of the circuit breaker. Calculation uses typical values from ABB series S200 as a reference. Actual values may differ due to used circuit breaker types and installation environment.

Harmonic distortion in the mains supply (at 230 V / 50 Hz and full load) in %

Type	THD	3	5	7	9	11
LCU 100W 12V SR top	13.1	4.9	3.3	2.4	0.8	0.4
LCU 96W 24V SR top	13.3	5.7	2	1	1	1

Wiring diagram

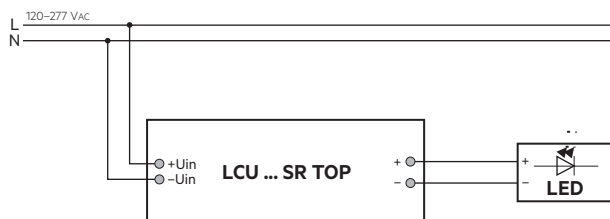

Installation instructions

The switching of LEDs on secondary side is not permitted. The functioning of the LCU in combination with dimming devices (e.g. PWM) cannot be guaranteed and has to be checked individually before using in combination.

To avoid the damage of the Driver, the wiring must be protected against short circuits to earth (sharp edged metal parts, metal cable clips, louver, etc.).

Wiring type and cross section

The wiring can be in stranded wires with ferrules or solid. For perfect function of the screw terminals the strip length should be 9-10 mm for the terminal.

The maximum secondary cable length at the terminals is 2 m. The LED wiring should be kept as short as possible to ensure good EMC.

Input / Output terminal

PRI and SEC:

20 AWG – 16 AWG

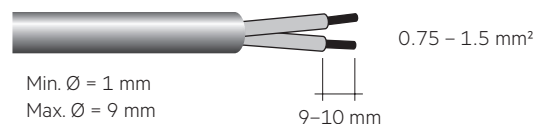

Release of the wiring:

The terminals have a simple push-in termination. Conductor removal via screwdriver (2.5 mm x 0.4 mm).

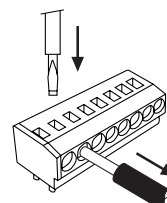

Insulation and electric strength testing of luminaires

Electronic devices can be damaged by high voltage. This has to be considered during the routine testing of the luminaires in production.

According to IEC 60598-1 Annex Q (informative only!) or ENEC 303-Annex A, each luminaire should be submitted to an insulation test with 500V_{DC} for 1 second. This test voltage should be connected between the interconnected phase and neutral terminals and the earth terminal. The insulation resistance must be at least 2MΩ.

As an alternative, IEC 60598-1 Annex Q describes a test of the electrical strength with 1500V_{AC} (or 1.414 x 1500V_{DC}). To avoid damage to the electronic devices this test must not be conducted.

Maximum number of switching cycles

All LED Driver are tested with 50,000 switching cycles. The actually achieved number of switching cycles is significantly higher.

Additional information

Additional technical information at www.tridonic.com → Technical Data

Guarantee conditions at www.tridonic.com → Services

Life-time declarations are informative and represent no warranty claim. No warranty if device was opened.

Diagrams for 12 V

Efficiency vs load

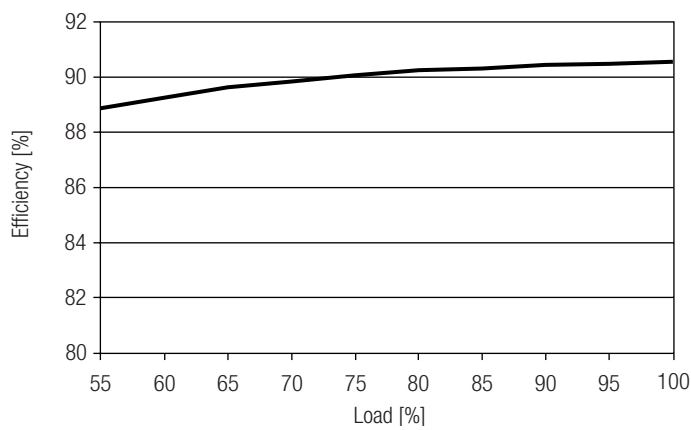

Power factor vs load

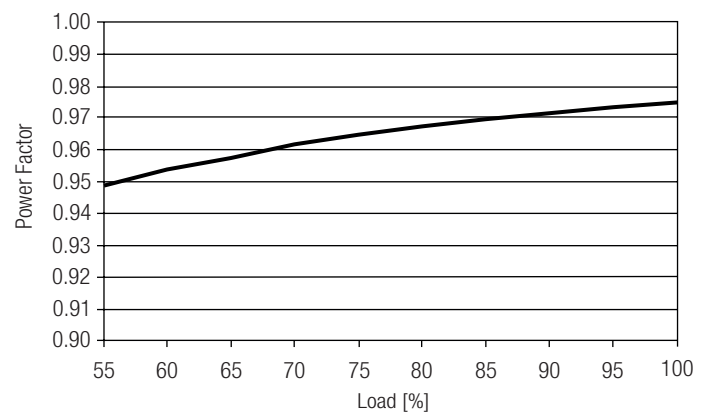

THD vs load

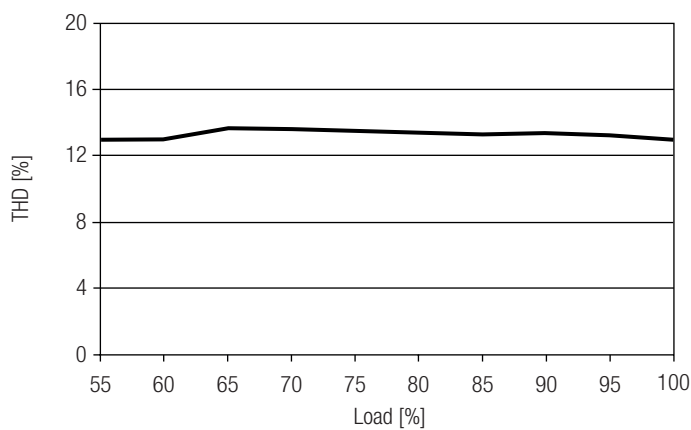

Diagrams for 24 V

Efficiency vs load

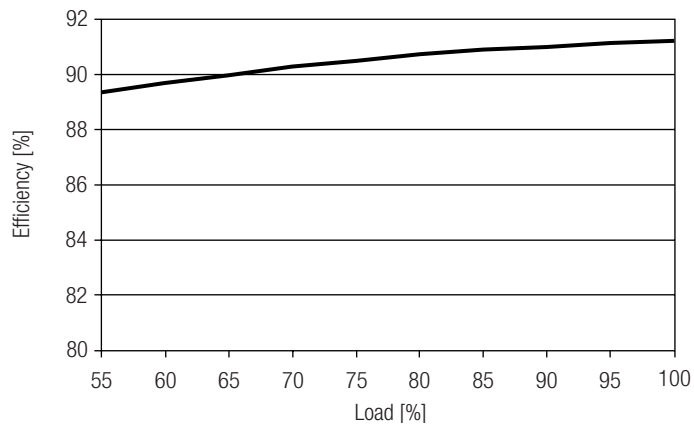

Power factor vs load

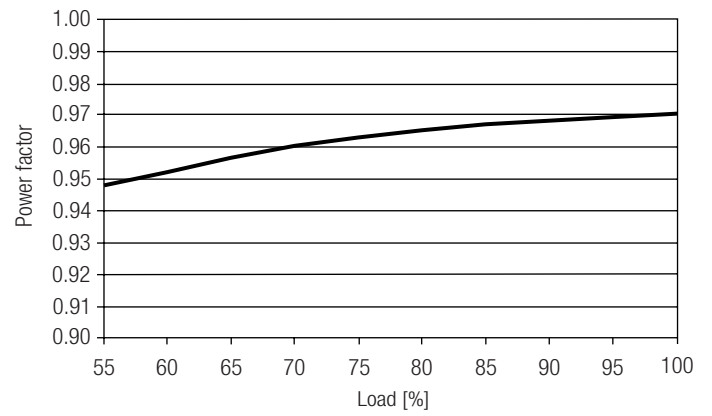

THD vs load

