

OBJÍMKY E10	LAMPHOLDERS E10	2
OBJÍMKY E14	LAMPHOLDERS E14	2 - 3
OBJÍMKY E27	LAMPHOLDERS E27	3 - 6
OBJÍMKY E40	LAMPHOLDERS E40	6
PŘÍSLUŠENSTVÍ OBJÍMEK	FACILITIES OF LAMPHOLDERS	6

Výrobky uvedené v katalogu jsou v souladu s evropskou direktivou 2006/95/EC včetně dodatků a jsou certifikovány dle norem ČSN EN 60 238. Shodu ověřil Elektrotechnický zkušební ústav Praha. Na výrobky jsou vystaveny certifikáty EZÚ (ESČ).

The products are in accordance with the European directive 2006/95/EC including amendments and are certified. The conformity was verified by the Elektrotechnický zkušební ústav Praha. The products have EZÚ (ESČ) certification.

## NÁVOD NA PŘIPOJOVÁNÍ A ODPOJOVÁNÍ VODIČŮ OBJÍMEK TYPU 1253, 1254, 1351 A 1352

### INSTRUCTIONS FOR CONNECTION AND DISCONNECTION OF CONDUCTORS OF LAMPHOLDERS TYPES 1253, 1254, 1351 AND 1352

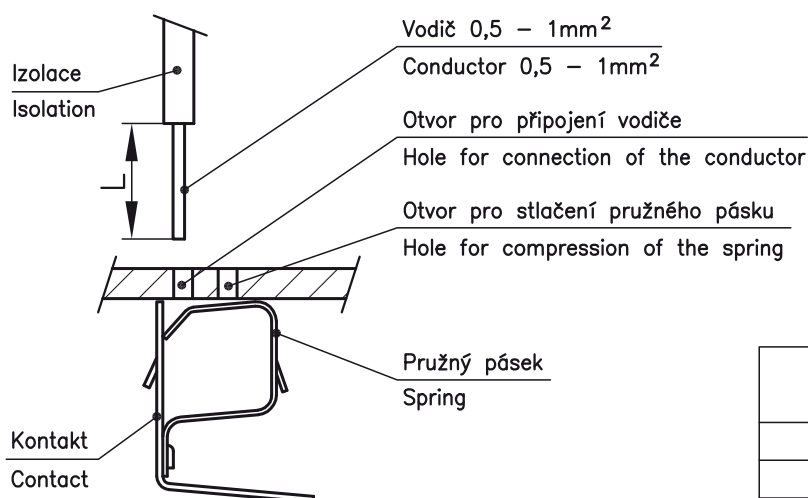



L(mm)	Použití pro typ Type
8 +1	1253, 1254
10 +1	1351, 1352

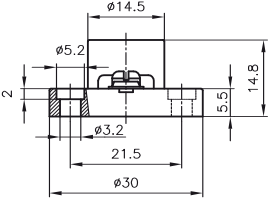

**OBJÍMKY E10**
**LAMPHOLDERS E10**

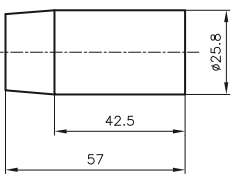
	Název / Technické údaje Name / Technical data	Barva Colour	Typové číslo Type number	Balení Packing
 	<p>0,5A, 250V</p> <p>Objímka vestavná (termoset) - uchycení 2x šroub M3</p> <p>Built-in lampholder (thermoset) - gripping with 2 screws M3</p>	černá black	1153-500	400

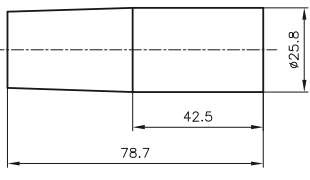
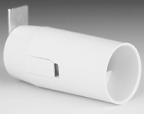
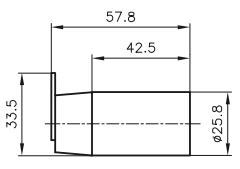

**OBJÍMKY E14**
**LAMPHOLDERS E14**

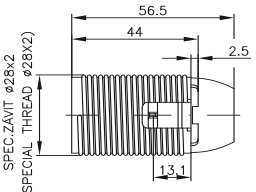
	Název / Technické údaje Name / Technical data	Barva Colour	Typové číslo Type number	Balení Packing
 	<p>2A, 250V, T170</p> <p>Objímka se závitovým vstupním otvorem (termoplast) - závitový vstupní otvor M10x1</p> <p>Threaded entry lampholder (thermoplastic material) - threaded entry M10x1</p>	černá black	1253-030	100
 	<p>2A, 250V, T170</p> <p>Objímka se závitovým vstupním otvorem (termoplast) - závitový vstupní otvor M10x1</p> <p>Threaded entry lampholder (thermoplastic material) - threaded entry M10x1</p>	černá black	1253-040	60
 	<p>2A, 250V, T170</p> <p>Objímka vestavná (termoplast) - uchycení: vestavný třmen 0,8 x 13 mm</p> <p>Built-in lampholder (thermoplastic material) - gripping : built-in yoke 0,8 x 13 mm</p>	černá black	1253-610	100
		bílá white	1253-614	100

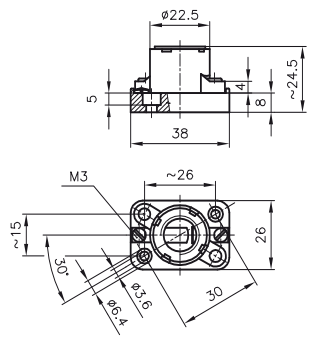
**OBJÍMKY E14**
**LAMPHOLDERS E14**

	Název / Technické údaje Name / Technical data	Barva Colour	Typové číslo Type number	Balení Packing
 	<p>2A, 250V, T 210 Objímka se závitovým vstupním otvorem a s vnějším závitem (termoplast) - závitový vstupní otvor M10x1</p> <p>Threaded entry lampholder with external thread (thermoplastic material) - threaded entry M10x1</p>	<p>černá black</p> <p>bílá white</p>	<p>1254-030</p> <p>1254-034</p>	<p>dle potřeb</p> <p>according to requirement</p>
 	<p>0,5A, 250V Objímka vestavná (thermoset) - uchycení 2x šroub M3</p> <p>Built-in lampholder (thermoset) - gripping with 2 screws M3</p>	<p>černá black</p>	<p>1255-500</p>	<p>200</p>

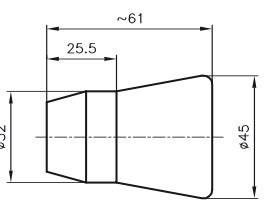
**OBJÍMKY E27**
**LAMPHOLDERS E27**

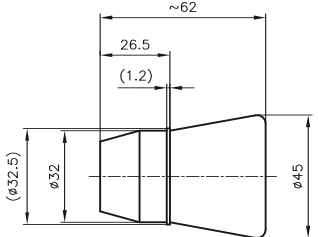
	Název / Technické údaje Name / Technical data	Barva Colour	Typové číslo Type number	Balení Packing
 	<p>4A, 250V</p> <p>Objímka se závitovým vstupním otvorem (thermoset, keramika) - závitový vstupní otvor M10x1</p> <p>Threaded entry lampholder (thermoset, ceramics) - threaded entry M10x1</p>	<p>černobílá, glazovaná</p> <p>black-and-white, glazed</p>	<p>1332-136</p>	<p>45</p>
 	<p>4A, 250V</p> <p>Objímka se závitovým vstupním otvorem (thermoset, keramika) - závitový vstupní otvor M10x1 - objímka splňuje požadavky pro svítidla třídy II</p> <p>Threaded entry lampholder (thermoset, ceramics) - threaded entry M10x1 - lampholder complies with requirements for lightings of II class</p>	<p>černobílá, glazovaná</p> <p>black-and-white, glazed</p>	<p>1332-146</p>	<p>45</p>

**OBJÍMKY E27**
**LAMP HOLDERS E27**

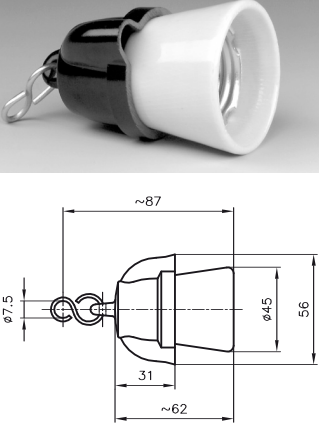
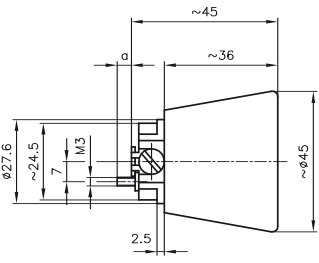
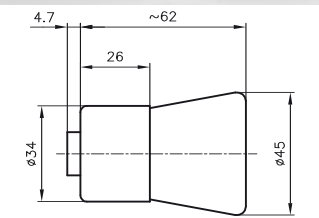
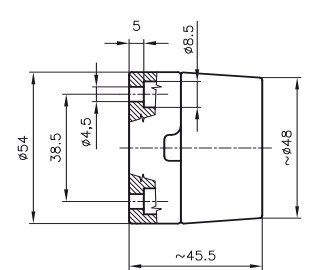
	Název / Technické údaje Name / Technical data	Barva Colour	Typové číslo Type number	Balení Packing
	4A, 250V  Objímka závěsná (thermoset, keramika)  Pendant type lampholder (thermoset, ceramics)	černobílá, glazovaná  black-and-white, glazed	1332-407	40
	4A, 250V  Objímka vestavná (keramika) - šroub M3  Built-in lampholder (ceramics) - screw M3  a = 5mm  a = 11mm	bílá, glazovaná  white, glazed	1332-667  1332-677	80  80
	4A, 250V Objímka se závitovým vstupním otvorem (keramika)  Threaded entry lampholder (ceramics)  - závitový vstupní otvor M10x1 - threaded entry M10x1  - závitový vstupní otvor M13x1 - threaded entry M13x1	bílá, glazovaná white, glazed  bílá, glazovaná white, glazed	1332-837  1332-857	40  40
	4A, 250V  Objímka iluminační soklová (keramika)  Backplate lampholder (ceramics)	bílá, neglazovaná  white, non-glazed	1333-510	20

**OBJÍMKY E27**
**LAMP HOLDERS E27**

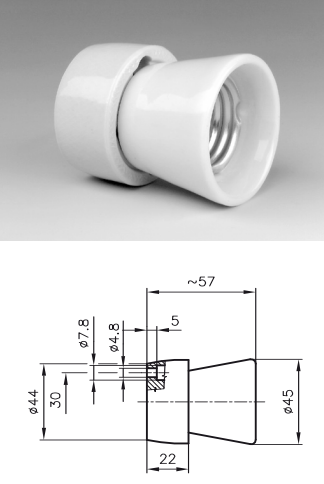
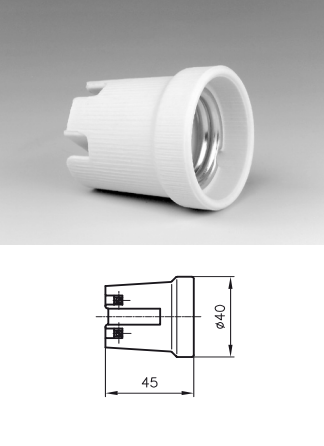
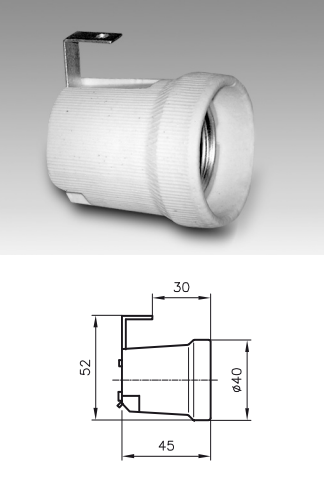
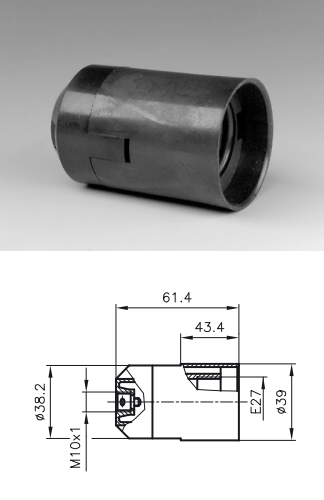
	<b>Název / Technické údaje</b> <b>Name / Technical data</b>	<b>Barva</b> <b>Colour</b>	<b>Typové číslo</b> <b>Type number</b>	<b>Balení</b> <b>Packing</b>
	<p>4A, 500V</p> <p>Objímka vestavná (keramika)                      - uchycení: 2x šroub M4                      - objímka splňuje požadavky pro svítidla třídy II</p> <p>Built-in lampholder (ceramics)                      - gripping with 2 screws M4                      - lampholder complies with requirements for lightings of II class</p>	<p>bílá                      - plášť glazovaný                      - čepička neglazovaná</p> <p>white,                      - covering glazed                      - cup non-glazed</p>	<p>1334-607</p>	<p>45</p>
	<p>4A, 250V, T210</p> <p>Objímka vestavná (keramika)</p> <p>Built-in lampholder (ceramics)</p>	<p>bílá, neglazovaná                      white, non-glazed</p>	<p>1335-607</p>	<p>50</p>
	<p>4A, 250V, T210</p> <p>Objímka vestavná (keramika),                      třmen se zemním šroubem</p> <p>Built-in lampholder (ceramics).                      yoke with earthing screw</p>	<p>bílá, neglazovaná                      white, non-glazed</p>	<p>1335-608</p>	<p>35</p>
	<p>4A, 250V</p> <p>Objímka se závitovým vstupním otvorem (termoplast)</p> <p>- závitový vstupní otvor M10x1                      - objímka splňuje požadavky pro svítidla třídy II</p> <p>Threaded entry lampholder (thermoplastic material)                      - threaded entry M10x1                      - lampholder complies with requirements for lightings of II class</p>	<p>černá                      black</p> <p>bílá                      white</p>	<p>1351-13000</p> <p>1351-13400</p>	<p>40</p> <p>40</p>

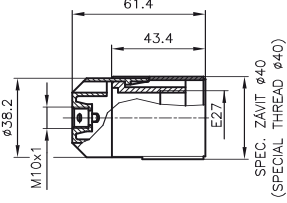

**OBJÍMKY E27**
**LAMPHOLDERS E27**

	Název / Technické údaje Name / Technical data	Barva Colour	Typové číslo Type number	Balení Packing
 	4A, 250V, Objímka se závitovým vstupním otvorem a s vnějším závitem (termoplast) - závitový vstupní otvor M10x1 - objímka splňuje požadavky pro svítidla třídy II	černá black	1352-13000	40
	Threaded entry lampholder with external thread (thermoplastic material) - threaded entry M10x1 - lampholder complies with requirements for lightings of II classe	bílá white	1352-13400	40

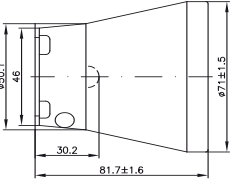
**OBJÍMKA E40**
**LAMPHOLDER E40**

	Název / Technické údaje Name / Technical data	Barva Colour	Typové číslo Type number	Balení Packing
 	18A, 500V Objímka vestavná E40 (keramika), - uchycení 2x šroub M5 - startovací napětí 5kV	bílá, neglazovaná	1430-607	dle potřeb according to requirement

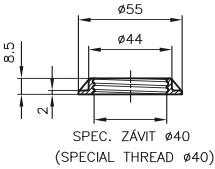
**PŘÍSLUŠENSTVÍ OBJÍMEK**
**LAMPHOLDERS FACILITIES**

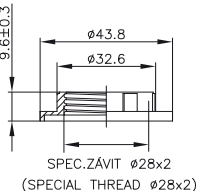
	Název / Technické údaje Name / Technical data	Barva Colour	Typové číslo Type number	Balení Packing
 	Závitový upevňovací kroužek pro objímky řady 1352 (termoplast)	černá black	1900-162	180
	Screw ring for lampholders 1352 (thermoplastic material)	bílá white	1900-161	180
 	Závitový upevňovací kroužek pro objímky řady 1254 (termoplast)	černá black	1901-162	dle potřeb
	Screw ring for lampholders 1254 (thermoplastic material)	bílá white	1901-161	according to requirement