



circuit breaker 3VA2 IEC frame 160 breaking capacity class H  
 $I_{cu}=85kA @ 415V$  3-pole, line protection ETU860, LSIG,  $I_n=40A$   
 overload protection  $I_r=16A...40A$  short-circuit protection  $I_{sd}=0.6..10x$   
 $I_n$ ,  $I_i=1.5..12x I_n$  N conductor protection optionally with external  
 current transformer, up to 160% gr.-fault prot., can be sw. off  $I_g=0.4...$   
 $1 x I_n$ ,  $t_g=0.05-0.8s$  nut keeper kit

Model	
Product brand name	SENTRON
Product designation	Molded case circuit breaker
Product version	Line protection
Design of the overcurrent release	ETU860
Protective function of the overcurrent release	LSIG
Number of poles	3

General technical data	
Rated insulation voltage $U_i$	800 V
Max. rated operational voltage $U_e$ with AC 50/60Hz	690 V
Power loss [W] / maximum	1.6 W
Active power loss / for rated value of the current / at AC / in hot operating state / per pole	0.53 W
Mechanical service life (switching cycles) / typical	20 000
Electrical endurance (switching cycles) / at AC-1 / at 380/415 V 50/60 Hz	12 000
Electrical endurance (switching cycles) / at AC-1 / at 690 V 50/60 Hz	8 000
Neutral conductors / upgradeable/retrofitable	Yes

Ground fault monitoring version	Summation current formation L-conductor
Product function	
• communication function	Yes
• other measurement function	Yes
Net weight	2.3 kg

### Current

Max. rated operational current of the frame size	160 A
Rated continuous current I <sub>u</sub>	40 A
Operating current	
• at 40 °C	40 A
• at 45 °C	40 A
• at 50 °C	40 A
• at 55 °C	40 A
• at 60 °C	40 A
• at 65 °C	40 A
• at 70 °C	40 A

### Switching capacity according to IEC 60947

Switching capacity class of the circuit breaker	H
Maximum short-circuit current breaking capacity (I <sub>cu</sub> )	
• at 240 V	110 kA
• at 415 V	85 kA
• at 440 V	85 kA
• at 500 V	55 kA
• at 690 V	2.5 kA
Operational short-circuit current breaking capacity (I <sub>cs</sub> )	
• at 240 V	110 kA
• at 415 V	85 kA
• at 440 V	85 kA
• at 500 V	55 kA
• at 690 V	2.5 kA
Short-circuit current making capacity (I <sub>cm</sub> )	
• at 240 V	242 kA
• at 415 V	187 kA
• at 440 V	187 kA
• at 500 V	121 kA
• at 690 V	3.8 kA

### Adjustable parameters

Adjustable response value current / I <sub>r</sub> min.	16 A
Adjustable response value current / I <sub>r</sub> max.	40 A
Adjustable response value time / t <sub>r</sub> min.	0.5

Adjustable response value time / tr max.	25
Adjustable response value current / Isd min.	24 A
Adjustable response value current / Isd max.	400 A
Short-term delayed / tripping switchable / I2t=ON/OFF	Yes
Adjustable response value time / tsd min.	0.05 s
Adjustable response value time / tsd max.	0.5 s
Adjustable response value time / tsd min.	0.05 s
Adjustable response value time / tsd max.	0.5 s
Adjustable response value current / li min.	60 A
Adjustable response value current / li max.	480 A
Ground fault protection can be switched ON/OFF	Yes
Ground fault protection / tripping switchable / I2t=ON/OFF	Yes
Adjustable response value current / lg min.	16 A
Adjustable response value current / lg max.	40 A
Adjustable response value current / tg min.	0.05 s
Adjustable response value current / tg max.	0.8 s
Adjustable response value current / for G-tripping / with I2t characteristic / min.	0.4 A
Adjustable response value current / for G-tripping / with I2t characteristic / max.	1 A

### Mechanical Design

Height [in]	7.1 in
Height	181 mm
Width [in]	4.1 in
Width	105 mm
Depth [in]	3.4 in
Depth	86 mm

### Connections

Arrangement of electrical connectors / for main current circuit	Front terminal
Type of electrical connection / for main current circuit	on both sides nut keeper kit
Type of connectable conductor cross-section, connection screw, width x thickness , min.	13 x 1 mm
Type of connectable conductor cross-section, connection screw, width x thickness , max.	25 x 8.5 mm

### Auxiliary circuit

Number of CO contacts / for auxiliary contacts	0
--	---

### Accessories





Product extension / optional / motor drive	Yes
--	-----



### Environmental conditions



Protection class IP / on the front	IP40
Ambient temperature	
<ul style="list-style-type: none"> <li>during operation / minimum</li> </ul>	-25 °C
<ul style="list-style-type: none"> <li>during operation / maximum</li> </ul>	70 °C
<ul style="list-style-type: none"> <li>during storage / minimum</li> </ul>	-40 °C
<ul style="list-style-type: none"> <li>during storage / maximum</li> </ul>	80 °C

### Certificates

Reference code / acc. to DIN EN 81346-2	Q
---	---

General Product Approval				EMC	
			<a href="#">Miscellaneous</a>		
CCC	VDE	CB			RCM

Declaration of Conformity	Test Certificates			Shipping Approval	
	<a href="#">Type Test Certificates/Test Report</a>	<a href="#">Miscellaneous</a>	<a href="#">Special Test Certificate</a>		
EG-Konf.				ABS	BUREAU VERITAS

Shipping Approval		other		
		<a href="#">CCS / China Classification Society</a>	<a href="#">Manufacturer Declaration</a>	<a href="#">Miscellaneous</a>
LRS	RMRS			

### Further information

**Information- and Downloadcenter (Catalogs, Brochures,...)**

<http://www.siemens.com/lowvoltage/catalogs>

**Industry Mall (Online ordering system)**

<https://mall.industry.siemens.com/mall/en/en/Catalog/product?mlfb=3VA2140-6KQ32-0AA0>

**Service&Support (Manuals, Certificates, Characteristics, FAQs,...)**

<https://support.industry.siemens.com/cs/ww/en/ps/3VA2140-6KQ32-0AA0>

**Image database (product images, 2D dimension drawings, 3D models, device circuit diagrams, ...)**

[http://www.automation.siemens.com/bilddb/cax\\_en.aspx?mlfb=3VA2140-6KQ32-0AA0](http://www.automation.siemens.com/bilddb/cax_en.aspx?mlfb=3VA2140-6KQ32-0AA0)

**CAX-Online-Generator**

<http://www.siemens.com/cax>

**Tender specifications**

<http://www.siemens.com/specifications>

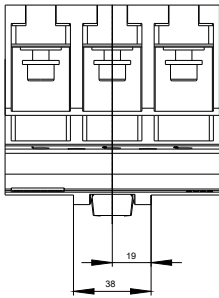
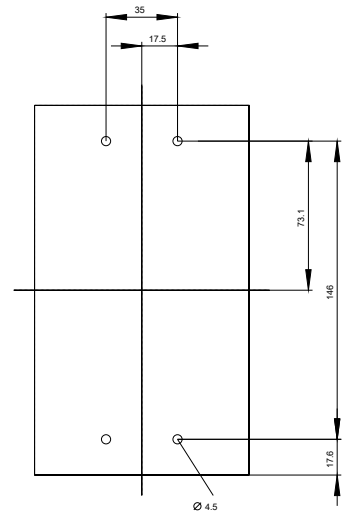
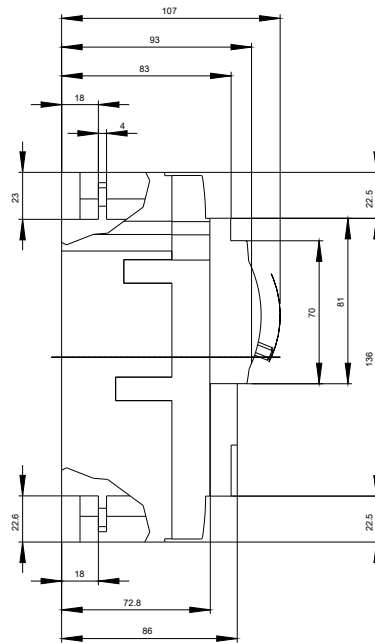
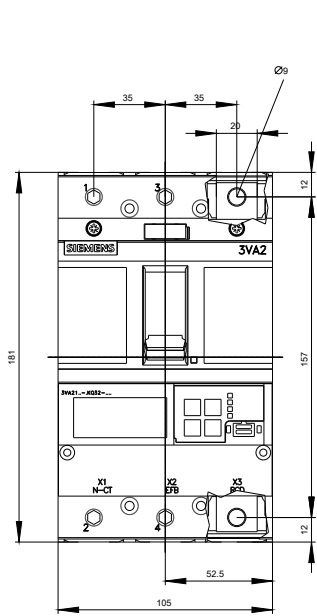

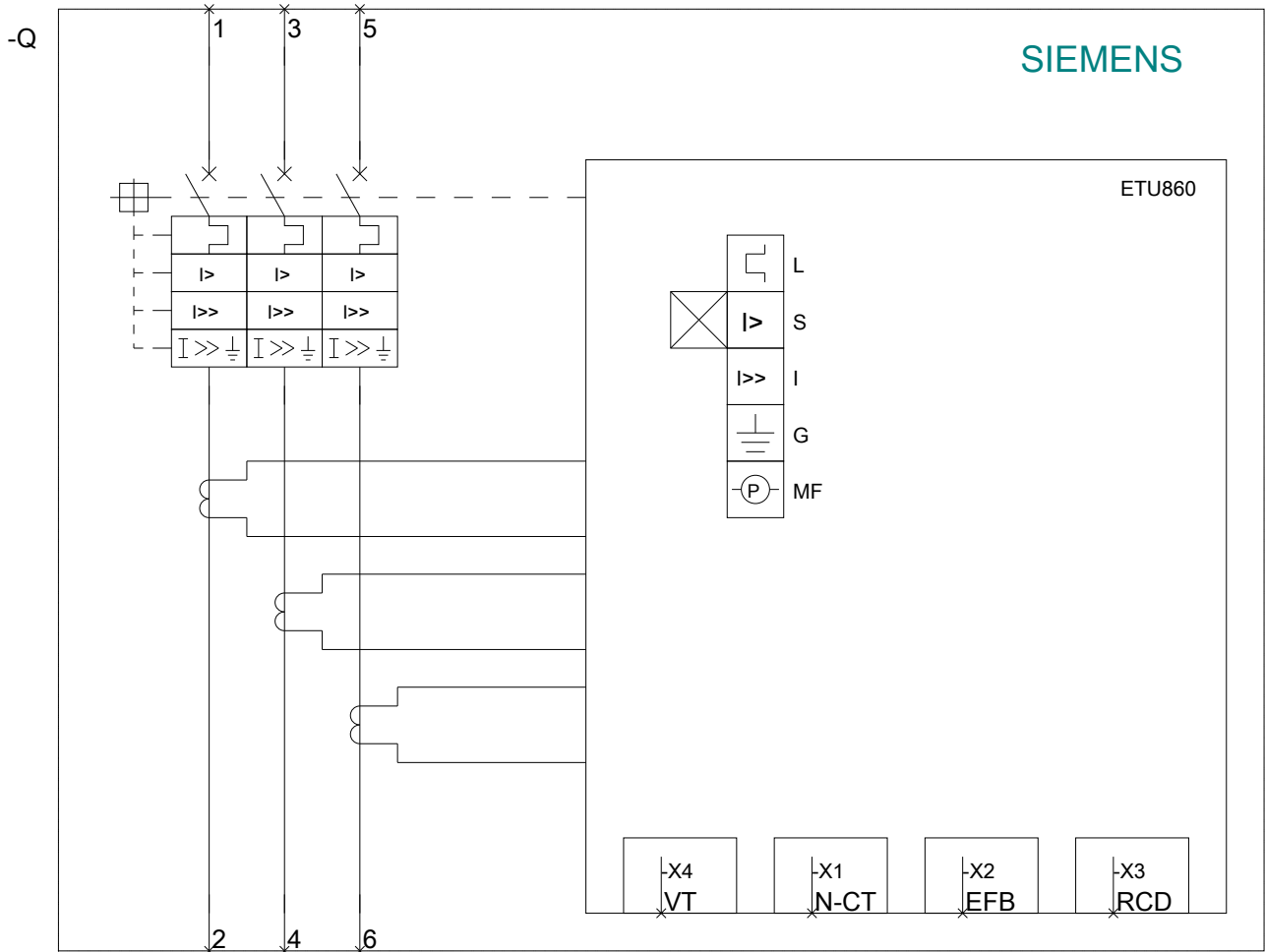

**last modified:**

04/15/2020