

front mounted rotary operator emergency-off with door interlock IEC
IP30/40 24V DC lighting kit accessory for: 3VA1 400/630 3VA2
400/630



Model	
Product brand name	SENTRON
Product designation	Accessories
Product version	Front rotary operating mechanism
Accessories	Front rotary operator
General technical data	
Protection class IP	IP30
Mechanical Design	
Height	94 mm
Width	138 mm
Depth	108 mm
Net weight	424 g
Certificates	

General Product Approval	EMC	Declaration of Conformity	Shipping Approval	other
Miscellaneous 	 RCM	 EG-Konf.	 LRS	Manufacturer Declaration

other
Miscellaneous

Further information

Information- and Downloadcenter (Catalogs, Brochures,...)

<http://www.siemens.com/lowvoltage/catalogs>

Industry Mall (Online ordering system)

<https://mall.industry.siemens.com/mall/en/en/Catalog/product?mlfb=3VA9467-0EK27>

Service&Support (Manuals, Certificates, Characteristics, FAQs,...)

<https://support.industry.siemens.com/cs/ww/en/ps/3VA9467-0EK27>

Image database (product images, 2D dimension drawings, 3D models, device circuit diagrams, ...)

http://www.automation.siemens.com/bilddb/cax_en.aspx?mlfb=3VA9467-0EK27

CAX-Online-Generator

<http://www.siemens.com/cax>

Tender specifications

<http://www.siemens.com/specifications>

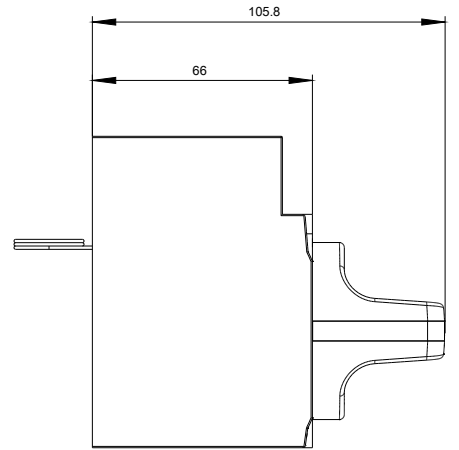
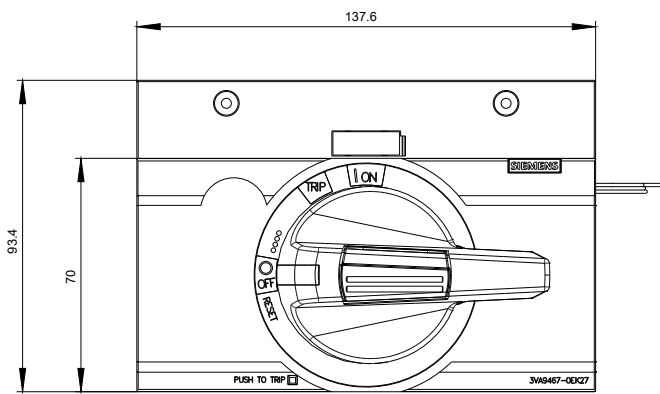

last modified:

05/06/2020