



11. VÝVODKY A SVORKOVNICE

- Záslepky a spojky
- Záslepky EX 
- Vývodky - PG a M
- Matice a membrány - PG a M
- Vývodky a matice EX - M 
- Krabicové spojky
- Svorkovnice



Referenční normy: EN 50 262

ZÁSLEPKY, ZÁTKY A SPOJKY

Barva: RAL 7035, záslepka EX: RAL 9005

		Gumová záslepka		Gumová záslepka 5 stupňová		Spojka s maticí a těsněním		Záslepka se závitem		Záslepka se závitem - EX			
		IP55		IP55		IP66		IP66		IP66/68*			
													
				GLOW WIRE 650 °C HALOGEN FREE	GLOW WIRE 960 °C	LIGHT	HEAVY DUTY						
		Do otvoru ∅	Katalogové číslo	Balení	Katalogové číslo	Balení	Katalogové číslo	Balení	Katalogové číslo	Balení	Katalogové číslo		
PG ZÁVIT	PG7	13							805.3380	100/1000			
	PG9	16							805.3381	100/1000			
	PG11	19							805.3382	100/1000			
	PG13,5	21							805.3383	100/1000			
	PG16	23	805.3304	100/1000	805.3314HF	100/1000	805.3314	100/100			805.3384	100/1000	
	PG21	29	805.3305	100/1000	805.3315HF	100/1000	805.3315	100/1000	805.3335	10/50		805.3385	100/1000
	PG29	37,5	805.3306	50/500				805.3336	10/50			805.3386	50/500
	PG36	47,5	805.3307	25/200				805.3337	5/25			805.3387	25/250
	PG42	54,5										805.3388	25/250
PG48	60										805.3389	25/250	

		Do otvoru ∅	Katalogové číslo	Balení	Katalogové číslo	Balení	Katalogové číslo	Balení	Katalogové číslo	Balení	Katalogové číslo	Balení	
METRICKÝ ZÁVIT	M12x1.5	12									805.5812	100/1000	805.EX5812.K
	M16x1.5	16									805.5816	100/1000	805.EX5816.K
	M20x1.5	20									805.5820	100/1000	805.EX5820.K
	M25x1.5	25					805.5225	10/50	805.5325	10/50	805.5825	100/1000	805.EX5825.K
	M32x1.5	32									805.5832	50/500	805.EX5832.K
	M40x1.5	40					805.5240	5/25	805.5340	5/25	805.5840	25/250	805.EX5840.K
	M50x1.5	50									805.5850	25/250	805.EX5850.K
	M63x1.5	63									805.5863	25/250	805.EX5863.K

* Pro záslepky se závitem EX, je krytí IP68 pouze za použití silikonového těsnění.

SVĚTLOST SPOJKY S MATICÍ			
Kat. číslo	A	Otvor	
805.3335	22 mm	PG21	
805.3336	27.8 mm	PG29	
805.3337	38.7 mm	PG36	
805.5225	19.6 mm	M 25x1.5	
805.5325	19.6 mm	M 25x1.5	
805.5240	33.6 mm	M 40x1.5	
805.5340	33.6 mm	M 40x1.5	

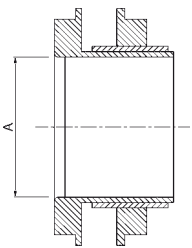

Referenční normy: EN 50 262, pro UNION - EX: IEC/EN 60079-0, IEC/EN 60079-1, IEC/EN 60079-7, IEC/EN 60079-31

VÝVODKY S PG A METRICKÝM ZÁVITEM

LIGHT

Stupeň krytí: IP66
 Provozní teplota: -5 °C až +60 °C
 Mechanická odolnost: IK05
 Materiál: odolný UV záření
 GLOW WIRE: 750°C

HEAVY DUTY *







Stupeň krytí: IP68
 Provozní teplota: -20°C až +80°C
 Mechanická odolnost: IK06
 Materiál: odolný UV záření, halogen free
 GLOW WIRE: 850°C

UNION - EX 

Materiál: polyamid, těsnění: silikon, EDPM
 Barva: RAL černá 9005
 Teplotní rozsah: M12: -20 °C až +80 °C
 M16-M63: -35 °C až +95 °C

EX klasifikace:

Atex code:  II 2GD
 EX provedení: Ex e II, Ex tb IIIC
 Stupeň krytí: IP66/68*
 Certifikát: LCIE 07 ATEX 6082 X

						S maticí		Bez matice		S maticí a membránou	Bez matice s membránou
											
						IP66	IP68*	IP66	IP68*	IP66	IP66
						LIGHT RAL 7035	HEAVY DUTY RAL 7004	LIGHT RAL 7035	HEAVY DUTY RAL 7004	LIGHT RAL 7035	LIGHT RAL 7035
						Katalogové číslo	Katalogové číslo	Katalogové číslo	Katalogové číslo	Katalogové číslo	Katalogové číslo
PG ZÁVIT	PG7	13	3-6	15	9,5	50/600	805.3340	805.3350		805.3340.1	
	PG9	16	4-8	19	9,5	50/600	805.3341	805.3351		805.3341.1	
	PG11	19	5-10	22	10	25/500	805.3342	805.3352		805.3342.1	
	PG13,5	21	7-12	24	12	25/600	805.3343	805.3353		805.3343.1	
	PG16	23	10-14	27	12	25/300	805.3344	805.3354		805.3344.1	
	PG21	29	13-18	33	14	25/400	805.3345	805.3355		805.3345.1	
	PG29	37,5	18-25	42	15	25/350	805.3346	805.3356		805.3346.1	
	PG36	47,5	22-32	53	17,5	10/140	805.3347	805.3357		805.3347.1	
	PG42	54,5	30-38	60	19	10/100	805.3348	805.3358		805.3348.1	
	PG48	60	34-44	68	20	10/100	805.3349	805.3359		805.3349.1	
METRICKÝ ZÁVIT	M12x1.5	12	3-6	15	9,5	50/600	805.5412		805.5412.0	805.5512.0	805.5412.2
	M16x1.5	16	4-8	19	9,5	50/600	805.5416		805.5416.0	805.5516.0	805.5416.2
	M20x1.5	20	7-12	24	12	25/500	805.5420		805.5420.0	805.5520.0	805.5420.2
	M25x1.5	25	13-18	33	14	25/400	805.5425		805.5425.0	805.5525.0	805.5425.2
	M32x1.5	32	18-25	42	15	25/350	805.5432		805.5432.0	805.5532.0	805.5432.2
	M40x1.5	40	22-32	53	17,5	10/140	805.5440		805.5440.0	805.5540.0	805.5440.2
	M50x1.5	50	30-38	60	19	10/100	805.5450		805.5450.0	805.5550.0	805.5450.2
	M63x1.5	63	34-44	68	14	10/100	805.5463		805.5463.0	805.5563.0	805.5463.2
	M12x1.5	12	4,5-6,5	15	15	1/1					
	M16x1.5/11	16	5,0-10,0	22	15	1/1					
	M20x1.5/16	20	10,0-14,0	27	15	1/1					
	M25x1.5/21	25	12,0-18,0	33	15	1/1					
	M32x1.5	32	16,0-25,0	42	15	1/1					
	M40x1.5	40	22,0-32,0	53	16	1/1					
	M50x1.5	50	28,0-38,5	60	16	1/1					
M63x1.5	63	40,0-48,0	70	16	1/1						

* Krytí IP68, pouze za použití gumového (pro HEAVY DUTY), nebo silikonového (pro UNION - EX) těsnění.

Tabulka použití vývodek pro kabel o průměru (mm):

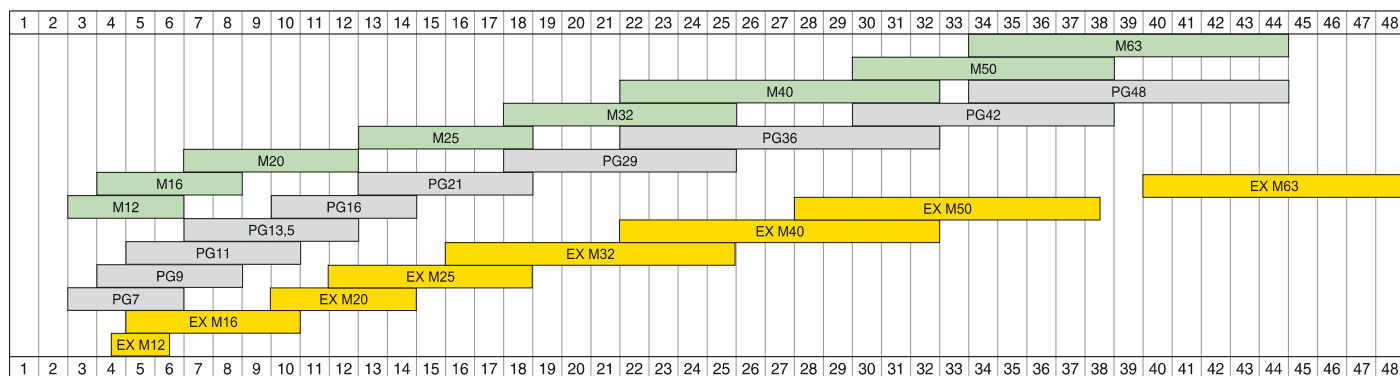

Balení	Matice		Gumové těsnění	Balení	Membrána	Vývodka EX	Matice EX	Silikonové těsnění
	Katalogové číslo	Katalogové číslo	Katalogové číslo		Katalogové číslo	Katalogové číslo	Katalogové číslo	Katalogové číslo
								
	LIGHT RAL 7035	HEAVY DUTY RAL 7004	LIGHT RAL 9005		LIGHT RAL 7035	IP66/68* UNION - EX RAL 9005	IP66/68* UNION - EX RAL 9005	IP66/68* UNION - EX RAL 9005
100/1000	805.3360	805.3370	805.3390	50	805.3340.9			
100/1000	805.3361	805.3371	805.3391	50	805.3341.9			
100/1000	805.3362	805.3372	805.3392	25	805.3342.9			
100/1000	805.3363	805.3373	805.3393	25	805.3343.9			
100/1000	805.3364	805.3374	805.3394	25	805.3344.9			
100/1000	805.3365	805.3375	805.3395	25	805.3345.9			
50/500	805.3366	805.3376	805.3396	25	805.3346.9			
50/500	805.3367	805.3377	805.3397	10	805.3347.9			
50/500	805.3368	805.3378	805.3398	10	805.3348.9			
50/500	805.3369	805.3379	805.3399	10	805.3349.9			
100/1000	805.5612	805.5712	805.5912	50	805.5412.9			
100/1000	805.5616	805.5716	805.5916	50	805.5416.9			
100/1000	805.5620	805.5720	805.5920	25	805.5420.9			
100/1000	805.5625	805.5725	805.5925	25	805.5425.9			
50/500	805.5632	805.5732	805.5932	25	805.5432.9			
50/500	805.5640	805.5740	805.5940	25	805.5440.9			
50/500	805.5650	805.5750	805.5950	10	805.5450.9			
50/500	805.5663	805.5763	805.5963	10	805.5463.9			
						805.EX5512.K	805.EX5712.K	805.EX5912.S
						805.EX5516.K	805.EX5716.K	805.EX5916.S
						805.EX5520.K	805.EX5720.K	805.EX5920.S
						805.EX5525.K	805.EX5725.K	805.EX5925.S
						805.EX5532.K	805.EX5732.K	805.EX5932.S
						805.EX5540.K	805.EX5740.K	805.EX5940.S
						805.EX5550.K	805.EX5750.K	805.EX5950.S
						805.EX5563.K	805.EX5763.K	805.EX5963.S

* Krytí IP68, pouze za použití gumového (pro HEAVY DUTY), nebo silikonového (pro UNION - EX) těsnění.

Referenční normy: EN 60998-1, EN 60998-2-1

KRABICOVÉ SPOJKY - T85

Jmenovité napětí: 450V~
Max. provozní teplota: +85°C
GLOW WIRE: 850°C



Krabicové spojky dělicí 10 pólové

Jmenovitý průřez	Výška	Délka	Barva	Balení	Katalogové číslo
1,5mm ²	9,8	96	<input type="checkbox"/>	50/500	812.372
2,5mm ²	12,2	120	<input type="checkbox"/>	50/250	812.374
4mm ²	12,2	120	<input type="checkbox"/>	50/250	812.375
6mm ²	14,7	145	<input type="checkbox"/>	25/150	812.376
10mm ²	17,0	168	<input type="checkbox"/>	25/100	812.378
16mm ²	21,3	211	<input type="checkbox"/>	25/75	812.379



Referenční normy: EN 60998-1, EN 60998-2-1

KRABICOVÉ SPOJKY - T85



Krabicové spojky netříděné IP20

Jmenovitý průřez	Jmenovitý proud	Barva	Balení	Katalogové číslo
1,5 mm ²	17,5A	Netříděné *	100/600	810.372/AS
		Průhledné <input type="checkbox"/>	100/600	810.372/TR
2,5 mm ²	24A	Netříděné *	100/1000	810.374/AS
		Průhledné <input type="checkbox"/>	100/1000	810.374/TR
4 mm ²	32A	Netříděné *	100/1000	810.375/AS
		Průhledné <input type="checkbox"/>	100/1000	810.375/TR
6 mm ²	41A	Netříděné *	100/1000	810.376/AS
		Průhledné <input type="checkbox"/>	100/1000	810.376/TR
10 mm ²	57A	Netříděné *	100/1000	810.378/AS
		Průhledné <input type="checkbox"/>	100/1000	810.378/TR
16 mm ²	76A	Netříděné *	50/500	810.379/AS
		Průhledné <input type="checkbox"/>	50/500	810.379/TR
25 mm ²	101A	Průhledné <input type="checkbox"/>	10/100	810.425/TR
35 mm ²	125A	Průhledné <input type="checkbox"/>	5/250	810.435/TR

* netříděné balení obsahují tyto druhy barev:



Krabicové spojky T85

Jmenovitý průřez mm ²	Otvor pro upevnění vodiče Ø mm ²	Jmenovitý proud A	Typ vodiče	Počet vodičů do svorky o průřezu mm ² (max. provozní teplota 85° C)											
				0,75	1	1,5	2,5	4	6	10	16	25	35	50	
1,5	3	17,5	pevný	2÷4	1÷3	1÷2	1								
			ohobný	2÷4	1÷3	1÷2	1								
2,5	4	24	pevný		3÷5	2÷3	1÷2	1							
			ohobný		2÷4	2÷3	1÷2	1							
4	4,6	32	pevný			3÷4	2÷3	1÷2	1						
			ohobný			3÷4	2÷3	1÷2	1						
6	6	41	pevný			3÷5	2÷3	1÷2	1÷2	1					
			ohobný			3÷4	2÷3	1÷2	1÷2	1					
10	8	57	pevný					3÷5	2÷4	1÷2	1				
			ohobný					3÷4	2÷3	1÷2	1				
16	10	76	pevný						3÷5	2÷3	1÷2	1			
			ohobný						3÷4	2÷3	1÷2	1			
25	12	101	pevný							2÷3	2÷3	2	1		
			ohobný							3÷5	2÷3	2÷3	2	1	
35	14	125	pevný								2÷4	1÷3	1÷2	1	
			ohobný									2÷4	1÷3	1÷2	1

Referenční normy: EN 60998-1, EN 60998-2-1

SVORKOVNICE - T140

Max. provozní teplota: +140 °C
GLOW WIRE: 850 °C
Barva: přírodní



Dělicí svorkovnice 12 polové

Jmenovitý průřez	Rozměry mm	Výška mm	Průměr svorky	Jmenovitá napětí	Balení	Katalogové číslo
2,5mm ²	95,5x15,5x16	8	2,6	250V~	50/800	815.1361
4mm ²	120x16,6x17,4	10	3,5	450V~	50/400	815.1362
6mm ²	120x16,6x17,4	10	3,5	450V~	50/400	815.13625
10mm ²	138x23,5x20,5	11,5	3,5	450V~	25/300	815.1363
16mm ²	174x30x24	14,5	4,3	450V~	25/150	815.1364
25mm ²	210x38x36	17,5	4,3	750V~	15/60	815.1365
35mm ²	264x46x39	22	5,5	750V~	10/40	815.1366

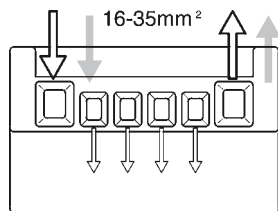
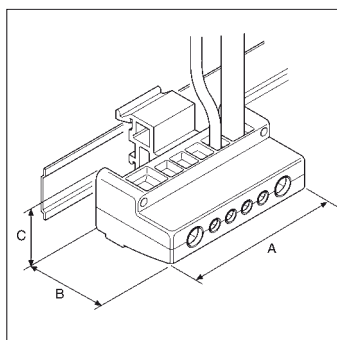

Referenční normy: EN 60998-1, EN 60998-2-1

ODBOČOVACÍ SVORKOVNICE

Jmenovitá napětí: 450V~
Max. provozní teplota: +85 °C
GLOW WIRE: 850 °C
Barva: transparentní



Odbočovací svorkovnice jednopólové - IP20

Jmenovitý průřez	Počet připojení	Průřez	Rozměry mm	Balení	Katalogové číslo
6mm ²	2	2x6mm ²	23x31x24	25/650	817.0602
	3	3x6mm ²	31x31x24	25/400	817.0603
	5	5x6mm ²	49x31x24	10/270	817.0605
16mm ²	2	2x16mm ²	33x28x24	10/270	817.1602
	3	3x16mm ²	45x28x24	10/270	817.1603
	5	5x16mm ²	71x38x24	10/260	817.1605
35mm ²	6	2x16mm ² + 4x6mm ²	66x38x24	10/260	817.1606C
	2	2x35mm ²	35x46x30	10/160	817.3502
	3	3x35mm ²	49x46x30	10/260	817.3503
	6	2x35mm ² + 4x16mm ²	83x46x30	10/120	817.3506C



Příslušenství pro odbočovací svorkovnice

Popis	Balení	Katalogové číslo
Držák svorkovnic na DIN lištu	10/500	817.001

Dělicí svorkovnice 12 pólové

Jmenovitý průřez mm ²	Otvor pro upevnění vodiče Ø mm ²	Jmenovitý proud A	Typ vodiče	Počet vodičů do svorky o průřezu mm ² T140 (max. provozní teplota 140° C)										
				0,75	1	1,5	2,5	4	6	10	16	25	35	
2,5	2,7	24	pevný	1÷3	1÷2	1	1							
			ohebný	1÷2	1÷2	1	1							
4	3	32	pevný	2÷4	1÷3	1÷2	1	1						
			ohebný	1÷2	1÷2	1	1	1						
10	4,4	57	pevný			1÷2	1÷2	1	1	1				
			ohebný			1÷2	1÷2	1	1					
16	5,5	76	pevný				2÷3	1÷2	1	1	1			
			ohebný				2	1÷2	1	1				
25	7,4	101	pevný					2÷4	2÷3	1	1	1		
			ohebný					2÷3	1÷2	1	1			
35	9	125	pevný						2÷4	1÷2	1	1	1	
			ohebný						2÷3	1÷2	1	1		

Odbočovací svorkovnice jednopólové - IP20

Jmenovitý průřez mm ²	Jmenovitý proud A	Typ vodiče	Počet vodičů do svorky o průřezu mm ² (max. provozní teplota 85° C)										
			1	1,5	2,5	4	6	10	16	25	35	50	
6	41	pevný		1÷6	1÷4	1÷3	1÷2						
	41	ohebný	1÷7	1÷5	1÷4	1÷3	1÷2						
16	76	pevný					1	1	1				
	76	ohebný					1÷4	1÷2	1				
35	125	pevný							1	1	1		
	125	ohebný							1÷2	1	1		